

# NATURE LOO ALECTURA

INSTRUCTION MANUAL FOR PREMIUM AND COMFORT MODELS

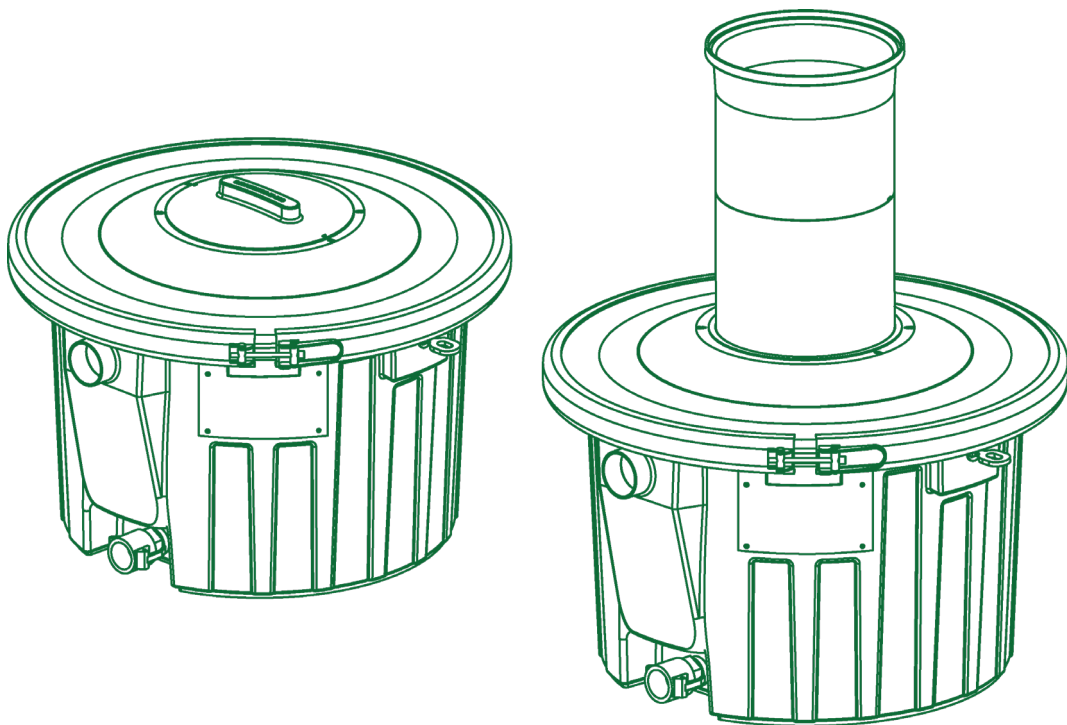

Scan QR code to find latest digital manual

IMNL-012-2024-08-21

©Ecoflo Wastewater Management Pty Ltd



# TABLE OF CONTENTS

SPECIFICATIONS	1
ITEMS INCLUDED	2
ITEMS REQUIRED (NOT INCLUDED)	4
TOOLS REQUIRED	4
SCHEMATICS	5
INSTALLATION	6
STEP 1: POSITION THE PEDESTAL	6
STEP 2: POSITION THE WASTE CHUTE	6
STEP 3: INSTALL THE WASTE CHUTE	8
STEP 4: SCREW INTERNAL AND EXTERNAL CHAMBER TOGETHER	10
STEP 5: INSERT THE ROUND RUBBER GROMMETS (COMFORT MODEL ONLY)	10
STEP 6: ASSEMBLE THE MIXER (PREMIUM MODEL ONLY)	11
STEP 7: INSTALL THE IN-SERVICE-CHAMBER	14
STEP 8: INSTALL THE VENTILATION PIPES AND FAN	15
STEP 9: CONNECT THE FLEXIBLE VENT PIPE AND LIQUID DRAIN HOSE	16
POWERING YOUR FAN	17
LEACHATE DRAIN	18
STARTING WITH AN EMPTY CHAMBER	19
OPERATION	20
ROTATING THE CHAMBERS	21
COMPOST ACCELERATORS	24
MAINTENANCE SCHEDULE	26
MAINTENANCE	27
TROUBLESHOOTING	28
PRODUCT & COMPONENT WARRANTY	30
CONTACT	31

# SPECIFICATIONS

<b>Chamber dimensions</b>	666mm L x 666mm W x 450mm H 26.22" L x 26.22" W x 17.71" H
<b>Dimensions including locking ring</b>	710mm L x 674mm W x 450mm H 27.95" L x 26.53" W x 17.71" H
<b>Underfloor clearance required</b>	Minimum 500mm (20")
<b>Volume per chamber</b>	90L (23.77 gal)
<b>Chamber material</b>	Moulded Acrylonitrile Styrene Acrylate (ASA)
<b>Power usage</b>	12V 5W Fan & transformer

BOX A (In-service chamber)

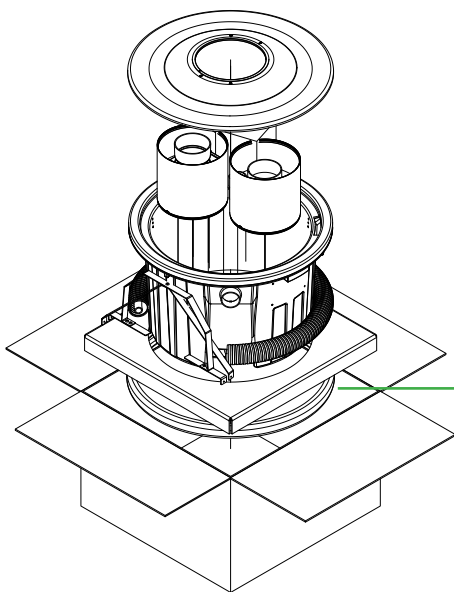

BOX B (Out-of-service chamber)

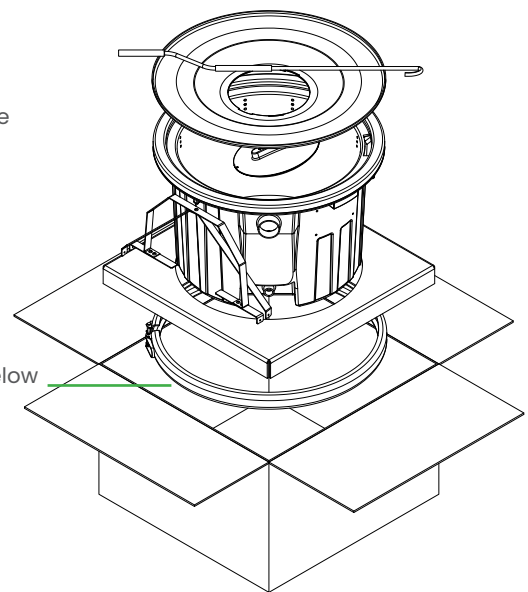

Mixer and crank handle  
only included with  
Premium model

Locking ring is located below  
the cardboard insert

As soon as your order arrives, even if you are not planning to install for some time, please open and check for any breakages, damage or shortages in your order.

All transit breakages must be reported within 7 days.

See back page for contact details.

# ITEMS INCLUDED

Please check the packing slip to ensure everything has been delivered. If anything is missing, please notify Ecoflo within 72 hrs of receipt.

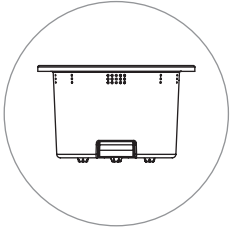

Internal chamber



External chamber

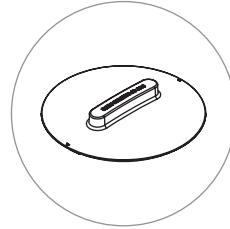

Out-of-service lid plug



Waste chute

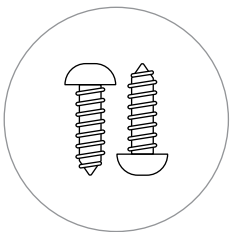

8G & 10G Pan screws



How-to-use sign

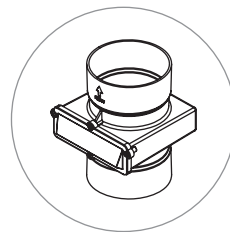

Fan in housing

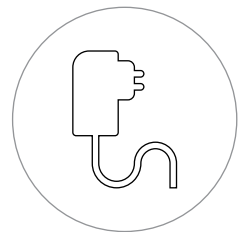

240-12V Transformer  
(110-12V for US customers)

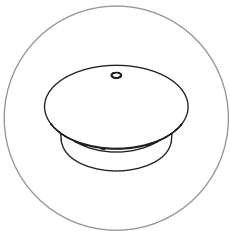

100mm Vent cowl

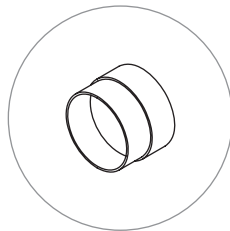

50mm Mozzie stopper

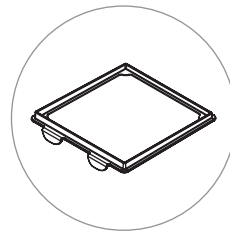

Fan mesh

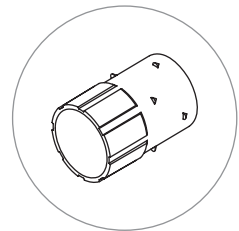

50mm Pipe connectors



L.I.T reducer

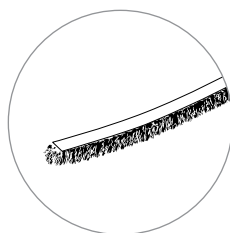

Brush seal

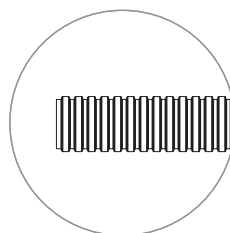

Vent pipe

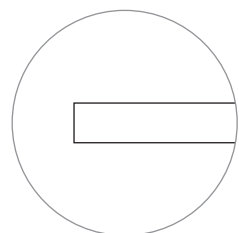

Excess liquids hose

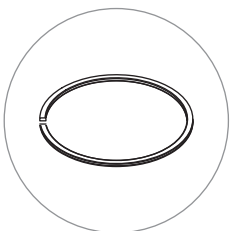

Rubber seal

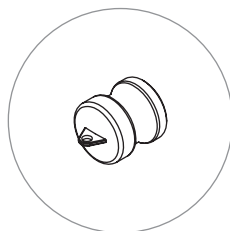

25mm Male dust plug

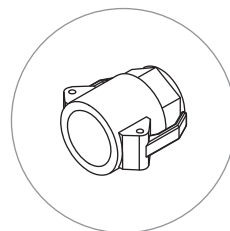

25mm Female BSP camlock

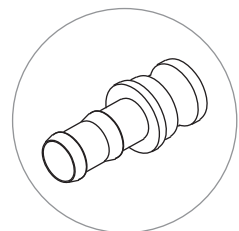

25mm Male barbed  
camlock

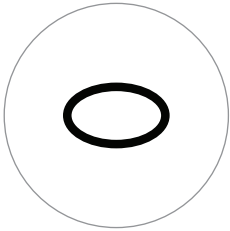

O-Ring

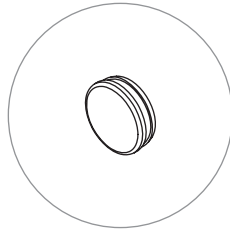

Round grommets

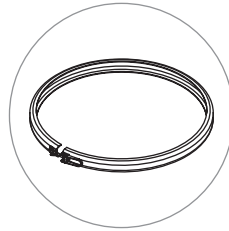

Locking ring

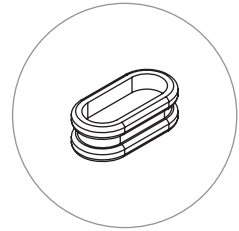

Oval grommets

## Alectura Premium Only



Mixer ring

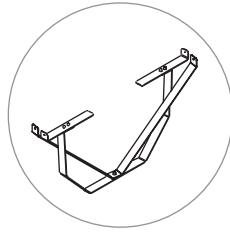

Mixer blades

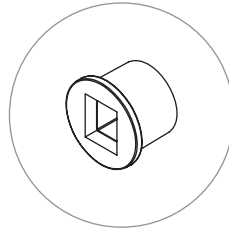

Mixer bushings

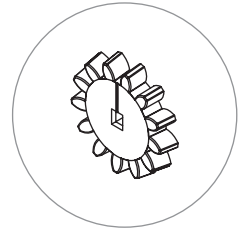

Mixer cog

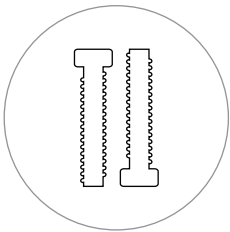

Machine screws

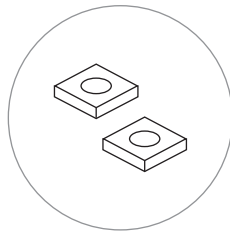

Square nuts

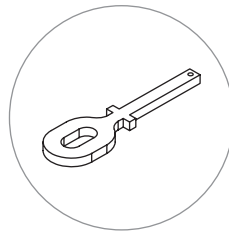

Mixer key

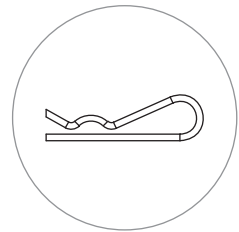

R-clip

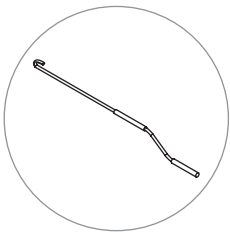

Crank handle

## Consumables

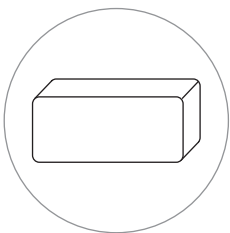

Bulking agent

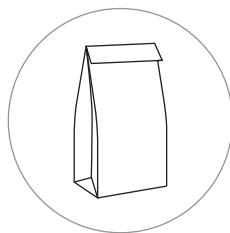

Microbes

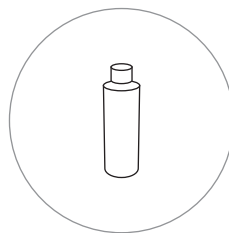

Enzymes



Spray bottle

Note: Consumables provided may differ slightly depending on country of purchase.

# ITEMS REQUIRED (NOT INCLUDED)

You will need the following items to complete your installation.

**A vent kit and drain kit are available to purchase separately from Ecoflo or your local supplier.**

## Vent items

- Wall brackets to fix the vent pipe to the building.
- A length of 100mm DWV vent pipe (for North American customers please use drain and sewer 4" SDR35 pipe) to the air exhaust (length depends on specific installation).
- Dektite required if vent pipe will penetrate the roof.



## Leachate drain items (please check with your local authority)

- 1.5m (5') of Ø100mm (4") slotted Agricultural pipe
- 100mm (4") of 1.5m (5') x 0.5m (20") Synthetic or Hessian geotextile mat
- ø 50mm (2") PVC pipe to connect the hose (supplied) to the agricultural pipe
- 0.30m<sup>3</sup> 20mm Aggregate

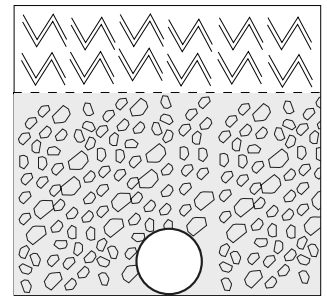

# TOOLS REQUIRED

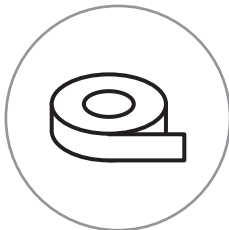

Plumbers Tape

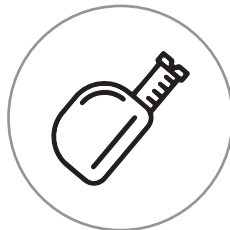

Tape Measure



Shovel

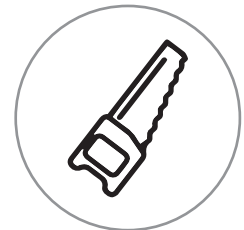

Hand Saw



Caulk Gun

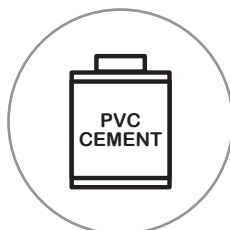

PVC Cement



Plumb Bob

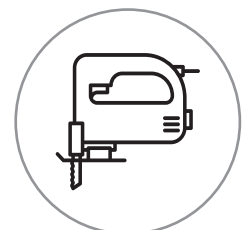

Jigsaw



Power Drill

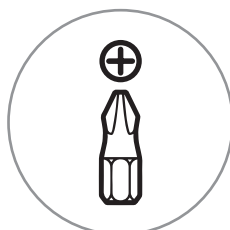

Philips Drill Bit

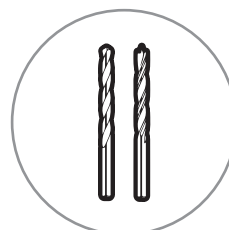

Masonry and Brad Point Drill Bits

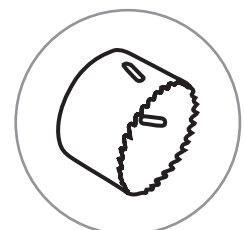

Hole Saw Drill Bit

# SCHEMATICS

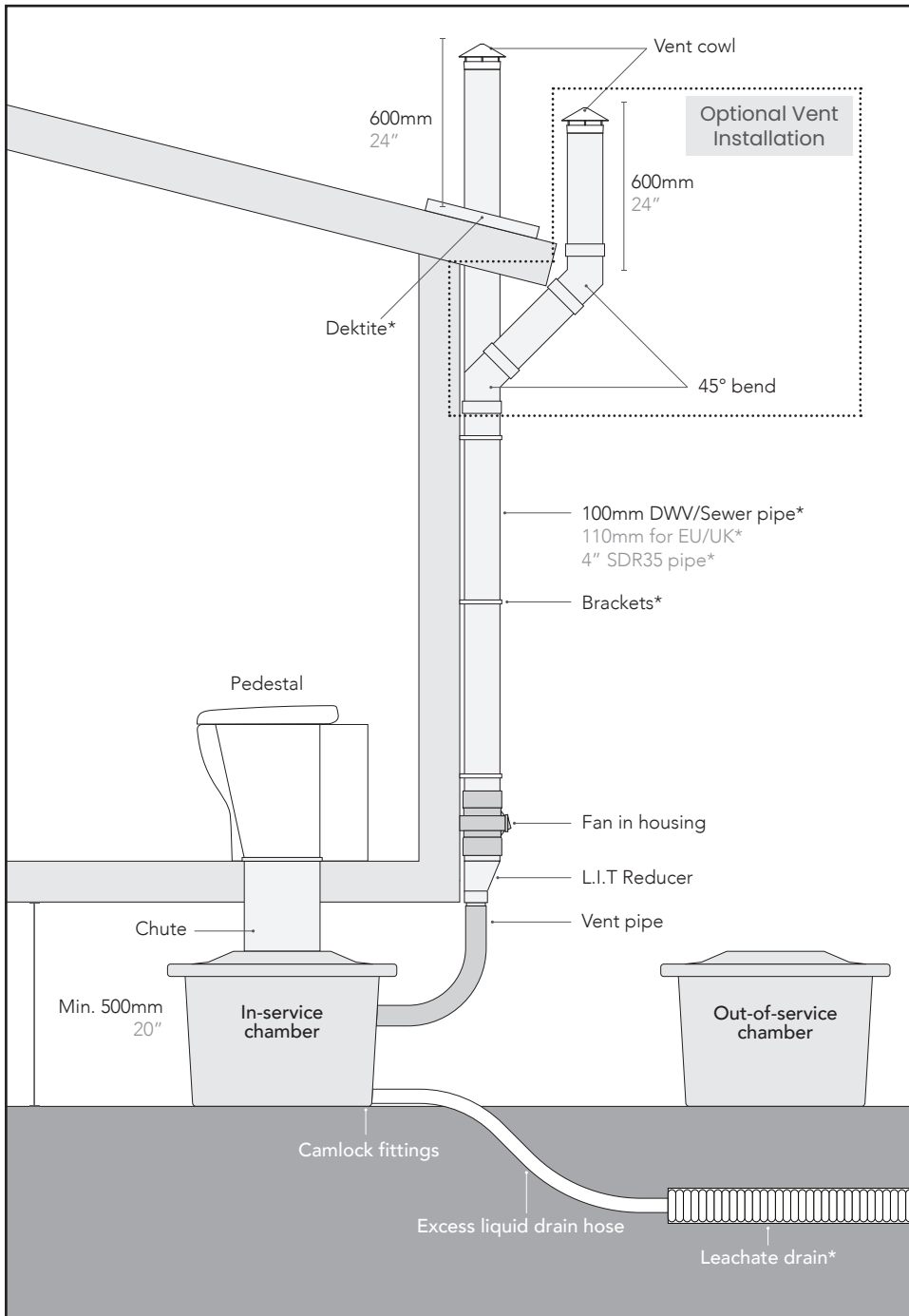

For North American customers, an adapter for the 100mm vent cowl is provided. The fan housing can accommodate both 100 DWV and SDR35 Pipe.

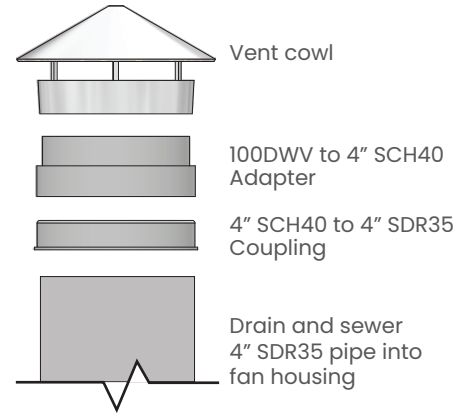

Ensure the name plate is facing in the direction of easiest access, to easily disconnect plumbing and venting when changing chambers.

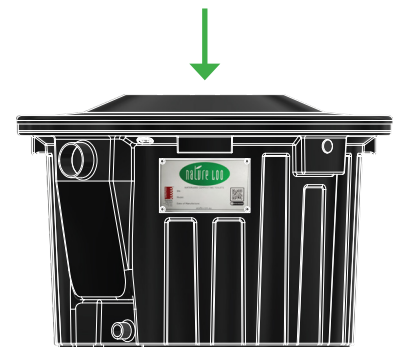

\* Not included in package.

A separate vent kit and drain kit are available to purchase from Ecoflo or your local hardware supplier.



If you are planning to excavate an area under the house for the compost chambers, please ensure the area is well-drained and any retaining walls are built to the satisfaction of the local authority.

# INSTALLATION

## STEP 1: POSITION THE PEDESTAL

Locate the approximate area where you want the pedestal to go before cutting the hole. The usual position for pedestals is centered between side walls. Refer to pedestal floor template.

**NOTE:** Due to the pedestals being man made, the distance to the center may vary from 245-255mm (9.64" -10"). Please check before cutting the hole.

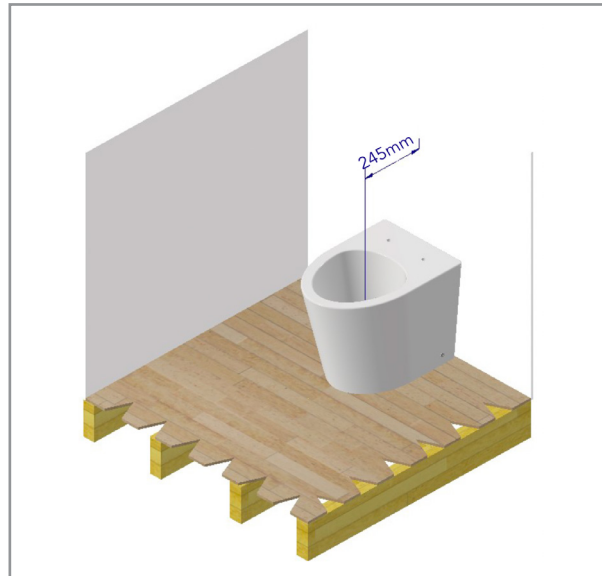

## STEP 2: POSITION THE WASTE CHUTE

A 240mm (9.44") hole must be cut in the toilet room floor to accommodate the waste chute.

**1**

Following the provided pedestal floor template, mark the location of the centre hole 245-255mm (9.64" -10") from the back wall. Drill a small hole.

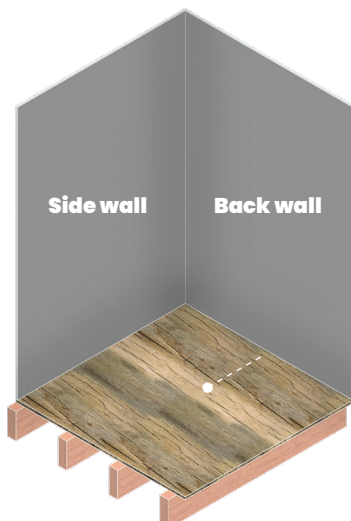

Go to the underfloor area and look for the hole you have drilled. Check to see if there is a floor joist, water pipe or electrical wiring under the area you are going to cut.



If there is a joist in the way, either reposition the waste hole OR install trimmer joists to each end of the cut joist. Fix all connections with galvanized framing anchors with 4 nails each leg (refer to diagram below).

### View from under floor

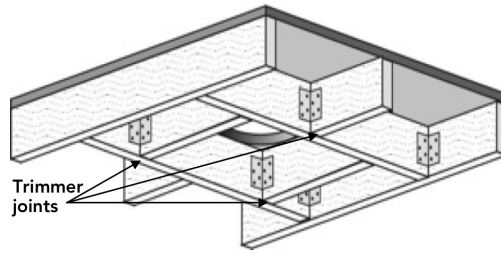

**2**

Following the pedestal floor template, draw a 240mm diameter circle. Cut out the hole with a jigsaw.



## STEP 3: INSTALL THE WASTE CHUTE

First ensure the pad or ground on which the 'In-service' chamber will reside is at its final level beneath the toilet room. It is recommended to install a concrete pad/tiles for the chamber to sit on.

- 1 Insert the top part of the chute into the hole and measure the amount of interlocking chute lengths you require. Extra lengths can be purchased separately from Ecoflo or local reseller. Add silicone glue between the pieces of chute before pushing them together. Push the top chute piece down into the bottom piece until you feel or hear them click together.

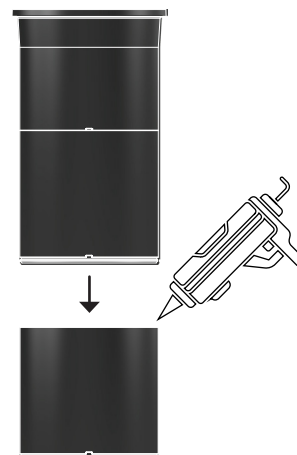
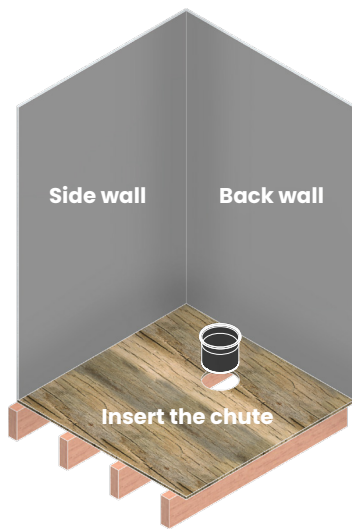

- 2 Slide the lid up the chute and place the chamber under. Mark where the chute meets the hole in the lid.

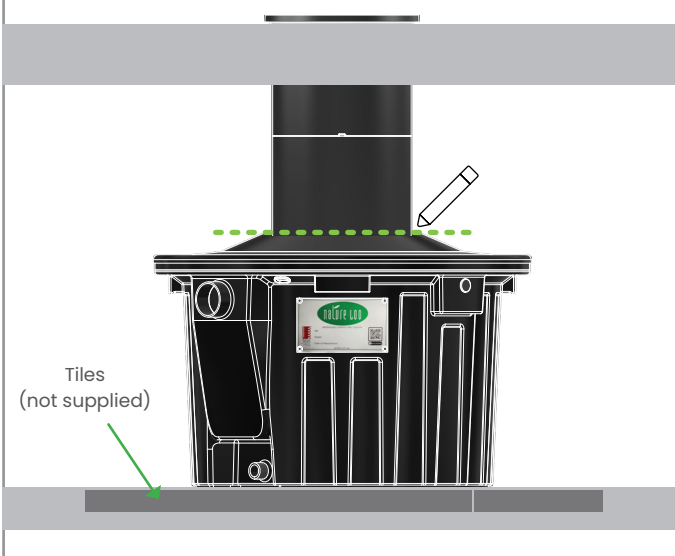

- 3 Cut off excess chute length 20mm ( $\frac{3}{4}$ " ) below the mark.

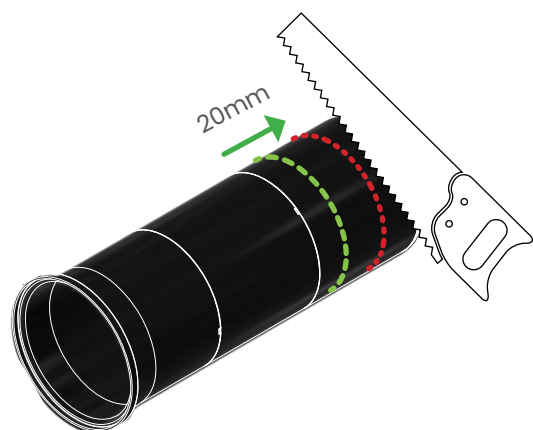

**4**

Mark a line 9mm above the bottom of the chute as a guide for the brush seal.

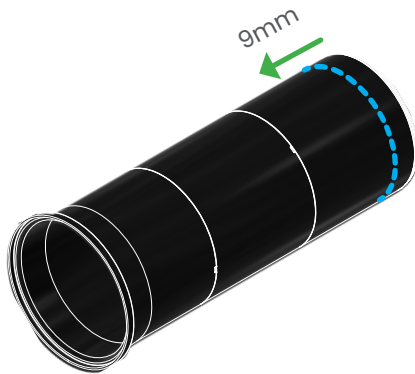

**5**

Place the chute into hole of the floor and seal with silicone.

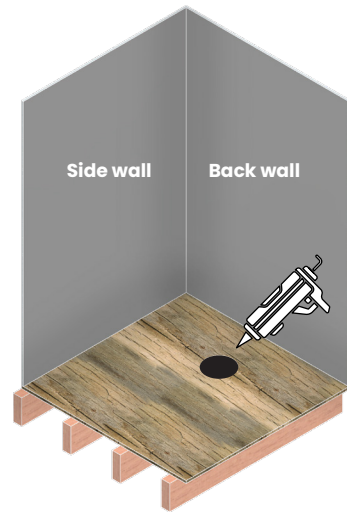

**6**

To install the pedestal, follow the instructions provided with the pedestal template.

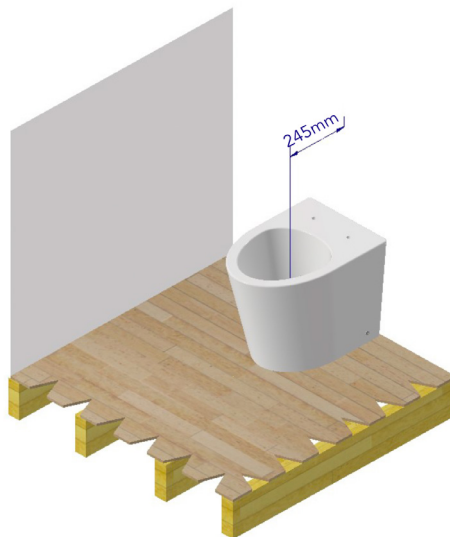

## STEP 4: SCREW INTERNAL AND EXTERNAL CHAMBER TOGETHER

Ensure the oval grommet is fitted to cover the oval hole on the external chamber. Make sure the 3 joining holes around the internal and external chambers are aligned. Secure with 10G pan screws.

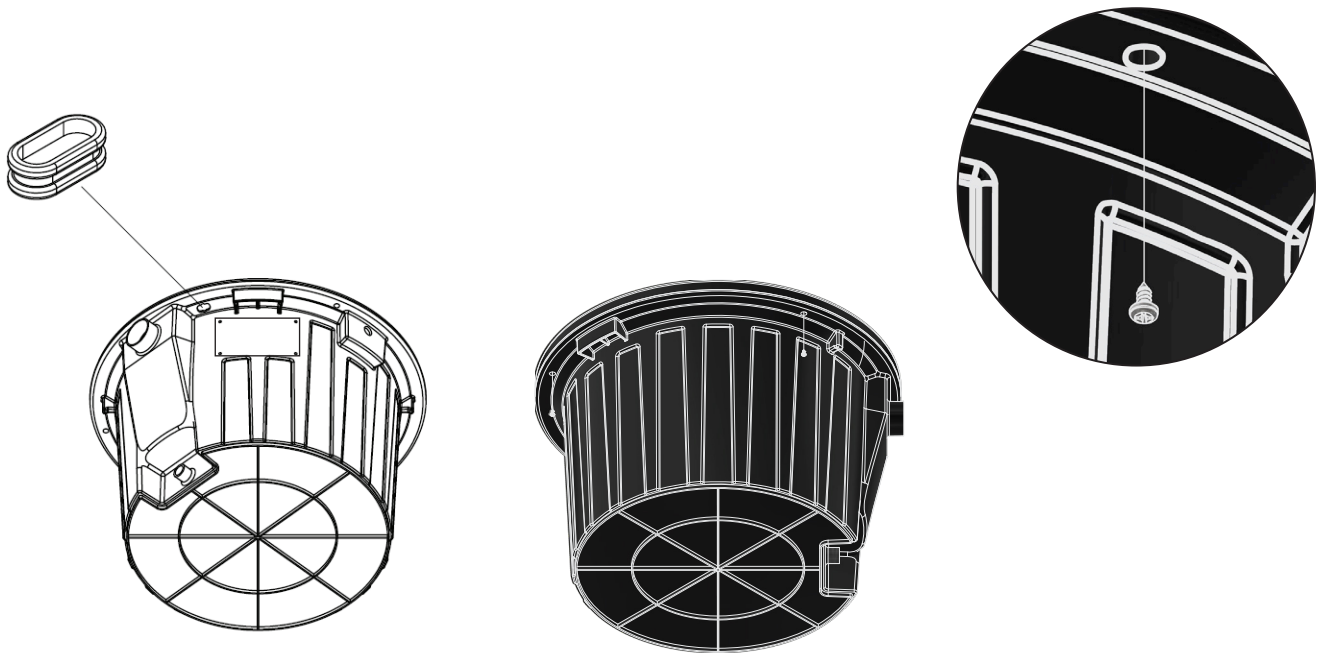

## STEP 5: INSERT THE ROUND RUBBER GROMMETS (COMFORT MODEL ONLY)

If you have the Alectura Premium; remove round grommets from tank and continue to Step 6.

If you have the Alectura Comfort; Insert the round rubber grommets into the holes to the right of the metal manufacturing plate and continue to Step 7.

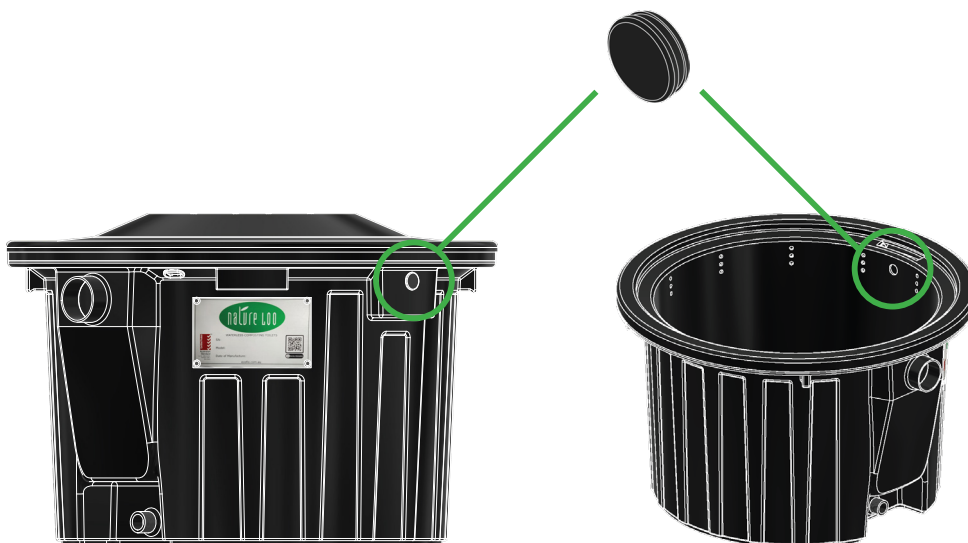

## STEP 6: ASSEMBLE THE MIXER (PREMIUM MODEL ONLY)

Skip this step if you have the Alectura Comfort.

### MIXER COG:

- 1** Insert the cog into the gear bay, with the smaller side facing inwards.

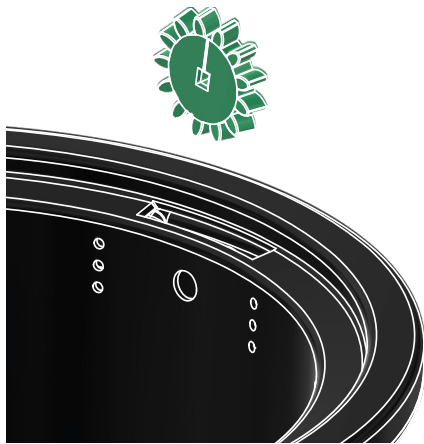

- 2** Insert a bushing into the external hole. Insert the key through bushing and cog. Insert the other bushing into the internal hole.

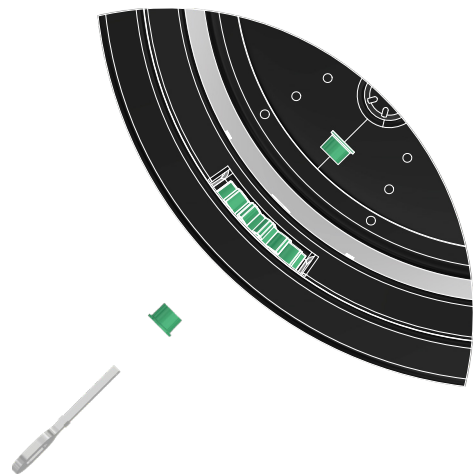

- 3** Secure the gear with the R-clip.

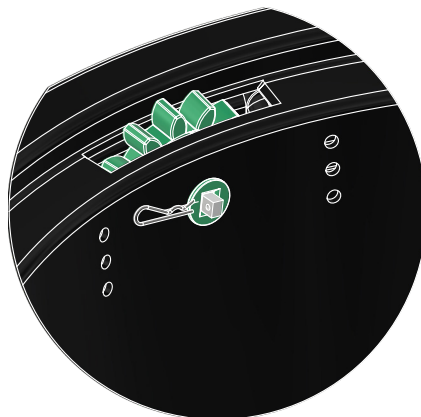

## MIXER RING AND BLADES ASSEMBLY:

**1** Unfold the steel blades.

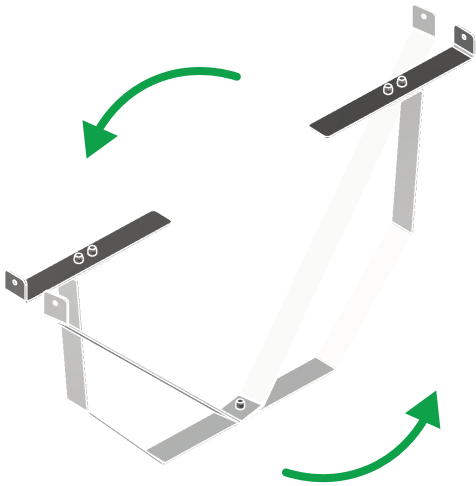

**2** Insert the steel blades into the ring.

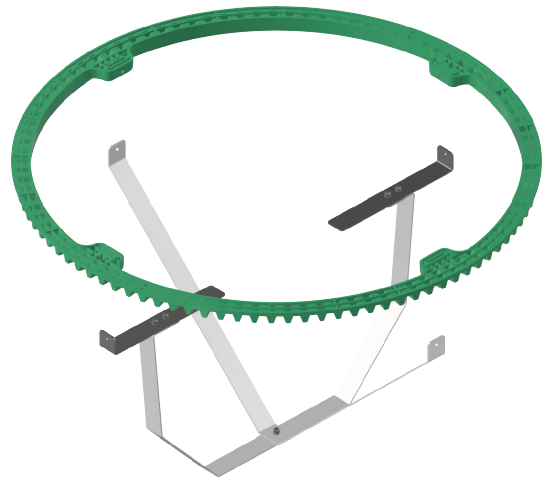

**3** Fasten blades to ring with machine screws and square nuts.

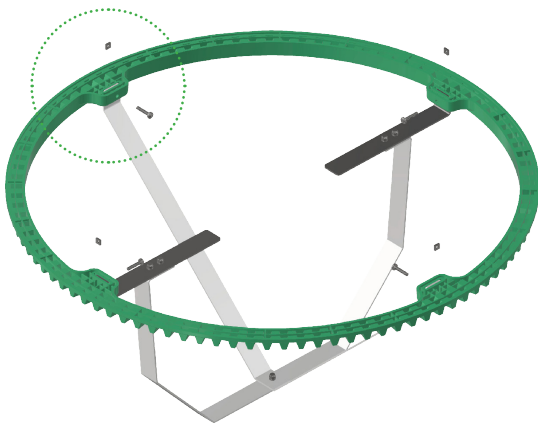

**4** Place the assembled mixer into the chamber.

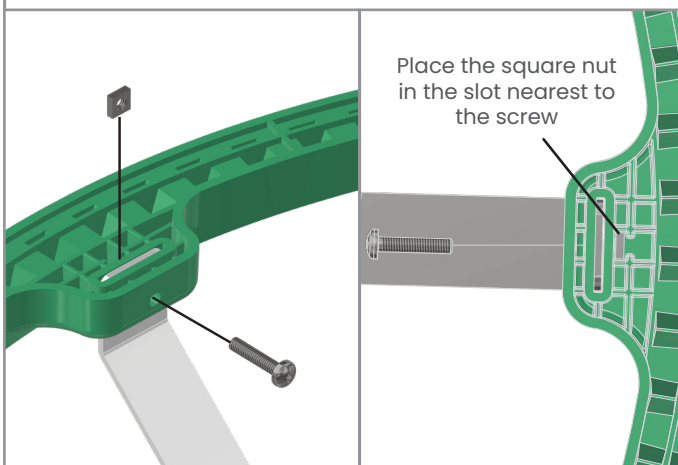
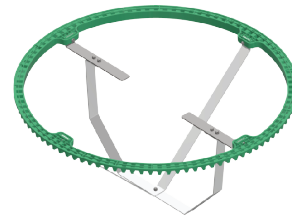

## OUT-OF-SERVICE CHAMBER

Repeat steps 4-6 to build the out-of-service chamber ready for installation.

## CRANK HANDLE

The mixer helps to flatten the “cone” buildup and aerate the pile, accelerating the composting process. To rotate the mixer, place the hook of the crank handle in the eyelet of the key and keep the crank handle level to the chamber. Turn clockwise and counterclockwise to avoid exerting excess pressure. If there is too much resistance, refer to the Troubleshooting section.

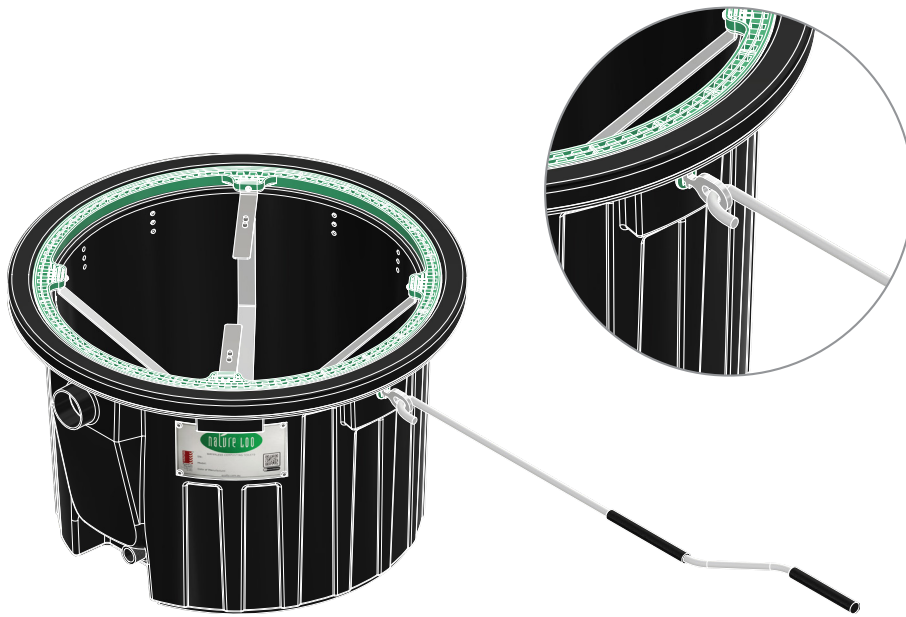

## MIXING THE IN-SERVICE CHAMBER



**It is advisable to mix the chamber contents fortnightly.** However, for systems experiencing extensive use by four or more individuals, a more frequent mixing schedule is required to prevent excess buildup.



## STEP 7: INSTALL THE IN-SERVICE-CHAMBER

- 1** Apply a bead of caulk inside the length of the seal. Attach the rubber seal to the hole of the lid. Ensure it is pushed on firm. Check that the lid still slides accordingly up the chute.

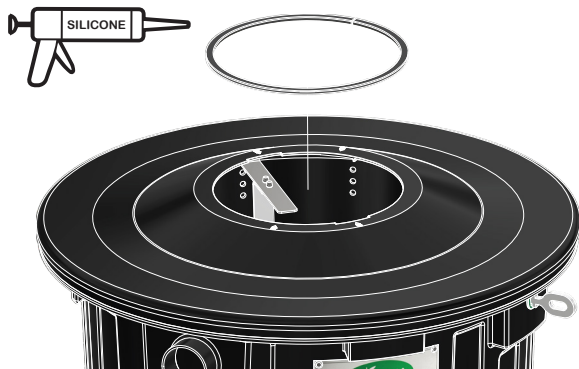

- 2** Add a 50mm (2") starter bed of bulking agent to the chamber. Slightly wet with water.

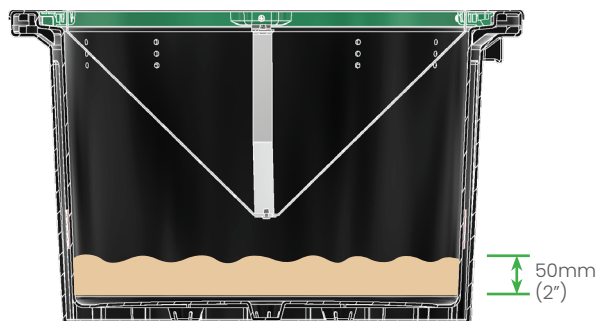

- 3** Slide the lid up the chute. Stick on the brush seal just above the marked line 9mm from the bottom of the chute.

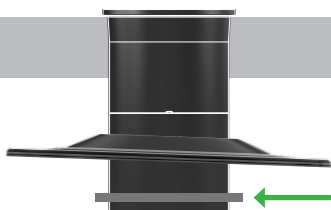

- 4** Place the chamber underneath the chute and lower the lid onto the chamber.



- 5** Hook the locking ring towards the back of the chamber to easily lock it in place. Adjust the nut and latch to suit. Only a small amount of tension is required.

Note: Increase tension to prevent child access if required.

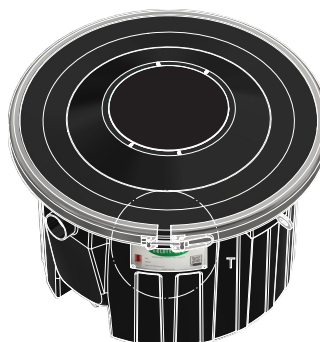
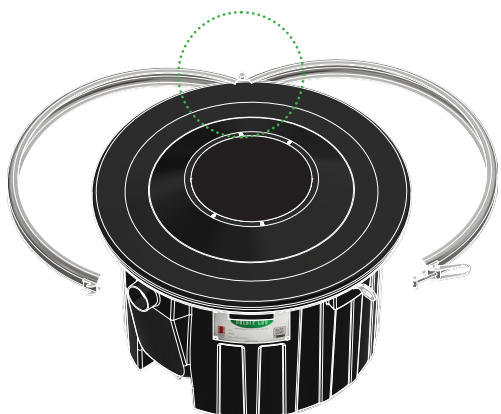



## STEP 8: INSTALL THE VENTILATION PIPES AND FAN

The fan is IP68 rated so will not be effected by moisture.

It is recommended that the fan runs 24 hours a day to continuously circulate air through the compost heap. Turn the fan off only when the system will not be in use for more than a few days.

Air is drawn down the toilet pedestal through the compost chamber and out the vent pipe.

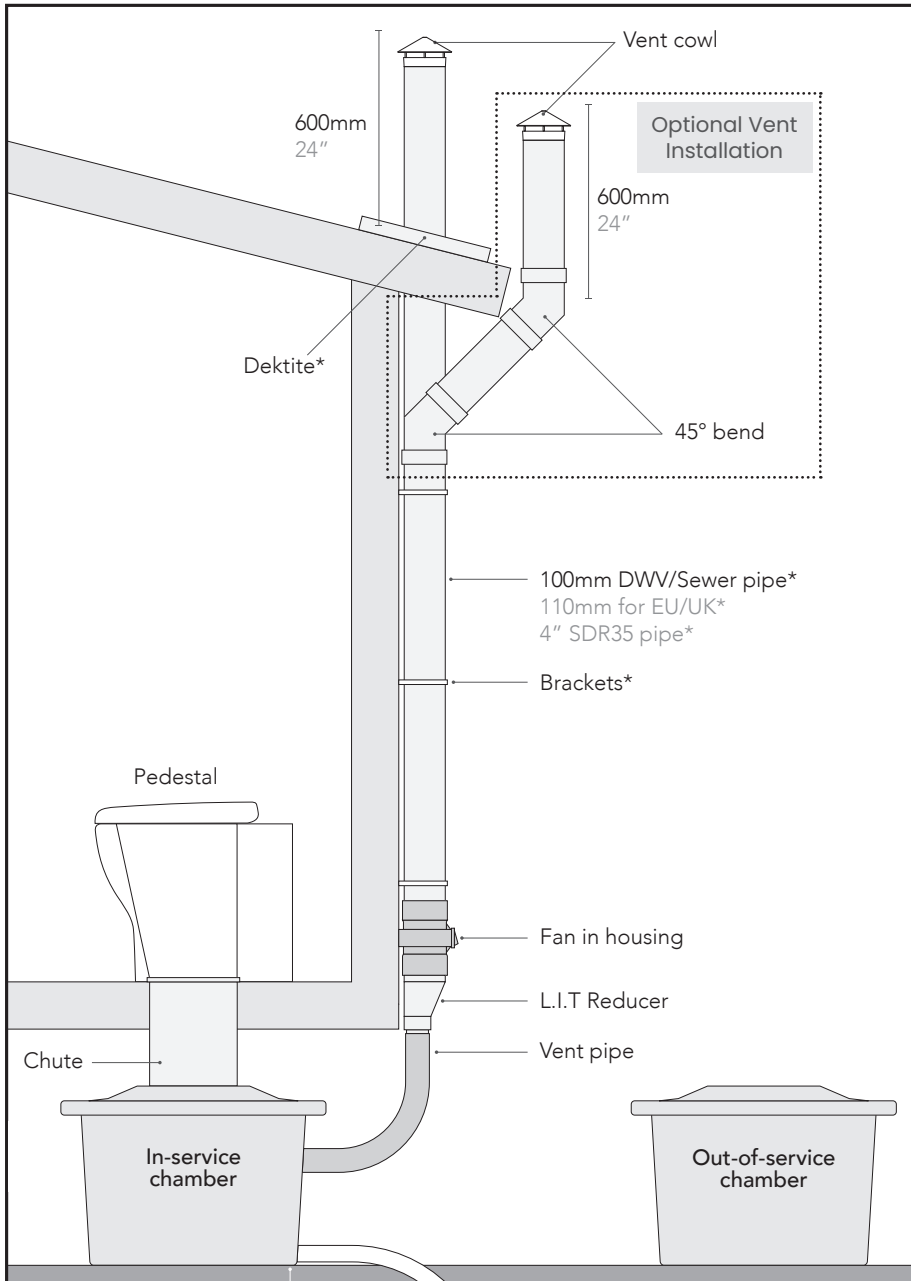

Do not glue the fan housing to the DWV fittings.

\* Not included in package

**A vent kit can be purchased separately from Ecoflo or your local supplier. It includes:**

- $\varnothing$ 100mm DWV Pipes ( sewer and drain 4" SDR35 pipe)
- $\varnothing$ 100mm DWV Slip Joiners (4" SDR35 Joiner)
- $\varnothing$ 100mm Stand Off Brackets (4" SDR35 Bracket)
- Dekтите



## STEP 9: CONNECT THE FLEXIBLE VENT PIPE AND LIQUID DRAIN HOSE

Connect the flexible vent pipe (black) and liquid drain hose (purple) to the chambers.

### Air vent outlet (1)

Insert the pipe connector into the vent outlet. If the fit is loose, wrap plumber's tape around the pipe connector.

### Liquid drain outlet (2)

To prevent any leakage, wrap 3-4 layers of plumber's tape around the length of the hose nipple before attaching the female camlock.



1



Wrap plumber's tape around the end of the pipe connector if it fits loosely into the vent outlet.



Pipe Connector



Flexible Vent Pipe

Dip the ends of the vent pipe into hot water for easier insertion of the pipe connectors.

2

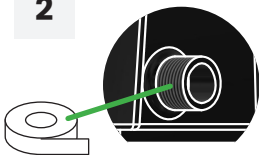

Apply 3-4 layers of plumber's tape around the nipple



O-Ring



Female Camlock

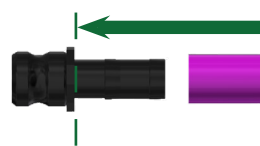

Male Barbed Camlock



Liquid Drain Hose

Dip the end of the hose into hot water for easier insertion of the barbed fitting. Ensure the hose is pushed entirely onto the barbed camlock.

Ensure there are no dips in the vent pipe.

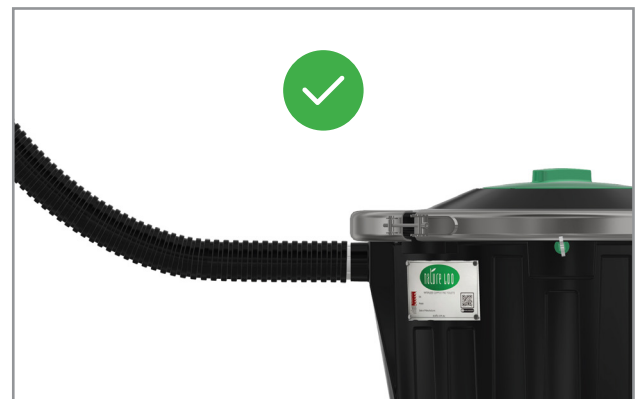

# POWERING YOUR FAN

A 3-12 volt regulated adjustable transformer is included to run the fan from mains power. If you have a solar panel, refer to the instructions provided with it. Note that transformer connections may differ slightly depending on country of purchase (see step 1 or step 3).

## Connecting the transformer to the fan:

- 1** If the housing has external IP plugs, simply connect the two plugs and screw the IP cap over the port to secure. If the transformer cables have wire stripped ends, proceed to **step 2**.

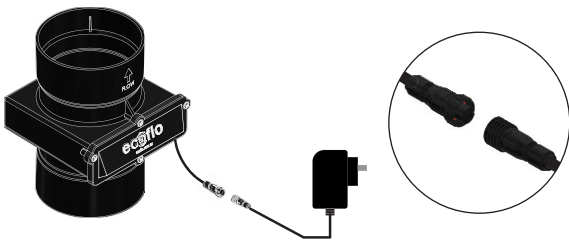

- 2** Unscrew the fan housing cover.

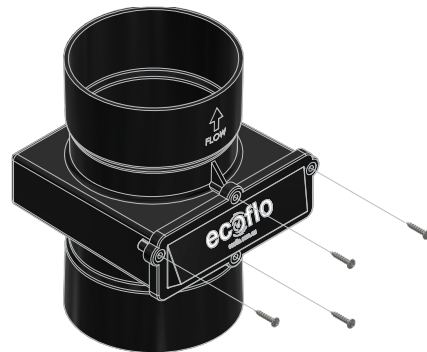

- 3** Attach the transformer cables to the terminal block as shown below.

**Black to black (negative)**  
**Red to black with white stripe (positive)**

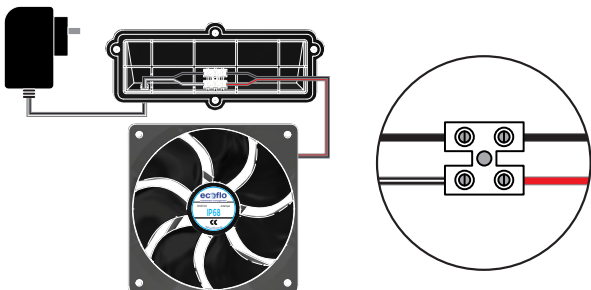

The fan has anti-polarity protection and will not run if connected incorrectly.

- 4** Insert the fan with sticker facing up and fan mesh into the housing, with the fan mesh on top.

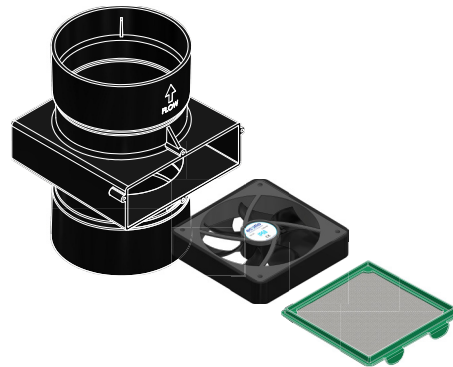

- 5** Test the fan. Airflow should be directed upwards, towards the top of the fan housing (see arrow). Screw fan cover back onto housing.

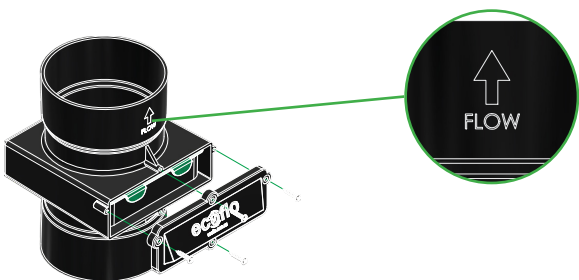

## Replacing the fan:

For fans connected with IP plugs, disconnect the fan as shown below and replace. For those with stripped cables, refer to step 2-5.

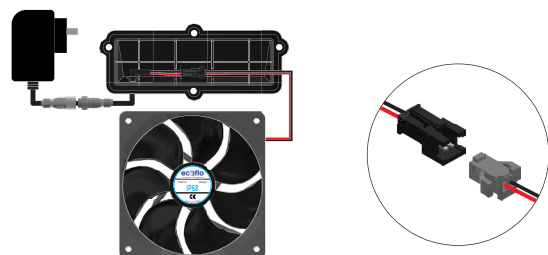

# LEACHATE DRAIN

A leachate drain kit (not including gravel) is available to purchase separately from Ecoflo Wastewater Management or your local supplier. Please check with local authority as local council requirements for drainage may differ.

Alternatively, if your council allows, you may wish to construct your own leachate drain. The liquid drain hose should run into either a 50mm (2") PVC pipe (drilled to allow liquid to escape) OR a length of slotted agricultural drainage pipe, buried in an absorption trench as shown in the diagram below.



**In accordance with Australian standards, the installation of a leachate drain or land application system is mandated for the proper operation of this system.**

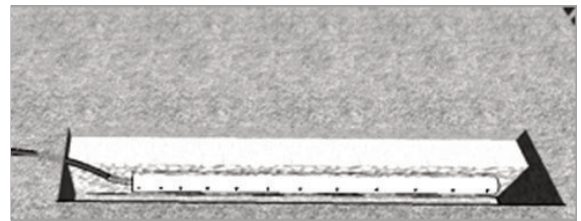
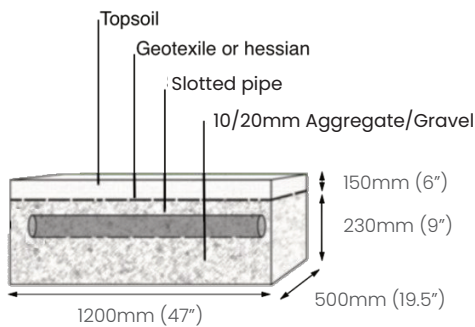

## Drainage Installation Options

### Agi Drain

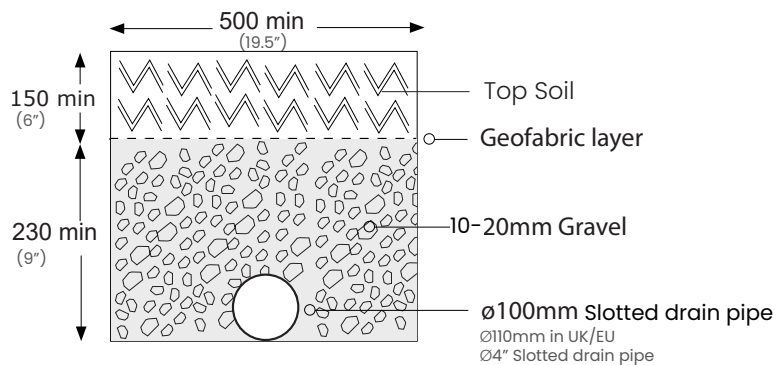

### Trench Arch Drain

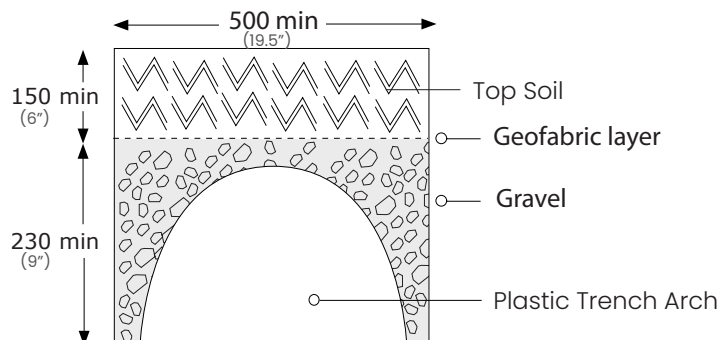

# STARTING WITH AN EMPTY CHAMBER

- 1** Before connecting your chamber to the waste chute, add an even 50mm layer of bulking agent and dampen slightly with water. Complete the installation of the chamber (refer to Step 7, Install the In-Service Chamber). You can start using your chamber now.

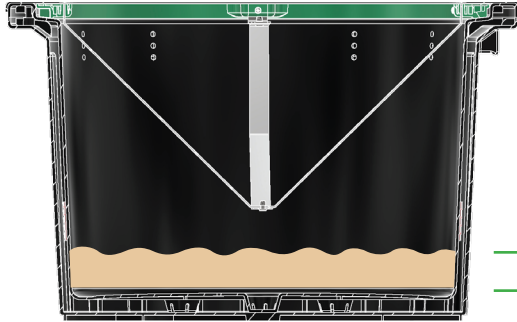

50mm  
(2")

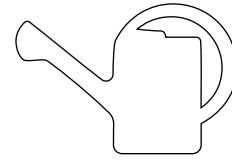

Slightly dampen the bulking agent with water.

- 2** After 7 days of use, mix a quarter packet of microbes (for countries other than Australia, please refer to the instructions on your locally supplied alternative) with warm water in a bowl. Add this to the chamber through the pedestal. Reseal the packet and store it at room temperature, out of direct sunlight.

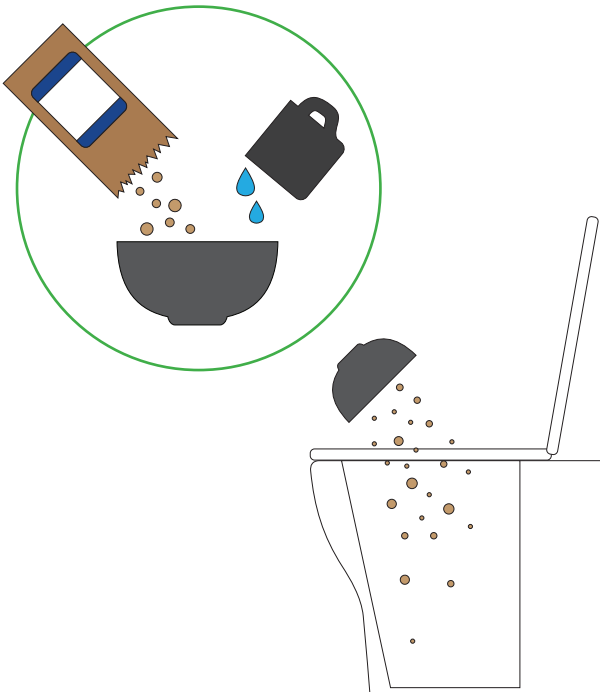

- 3** Around 14 days later, add another quarter of the packet of microbes mixed with warm water to the chamber through the pedestal. Your system is now fully activated with live bacteria.

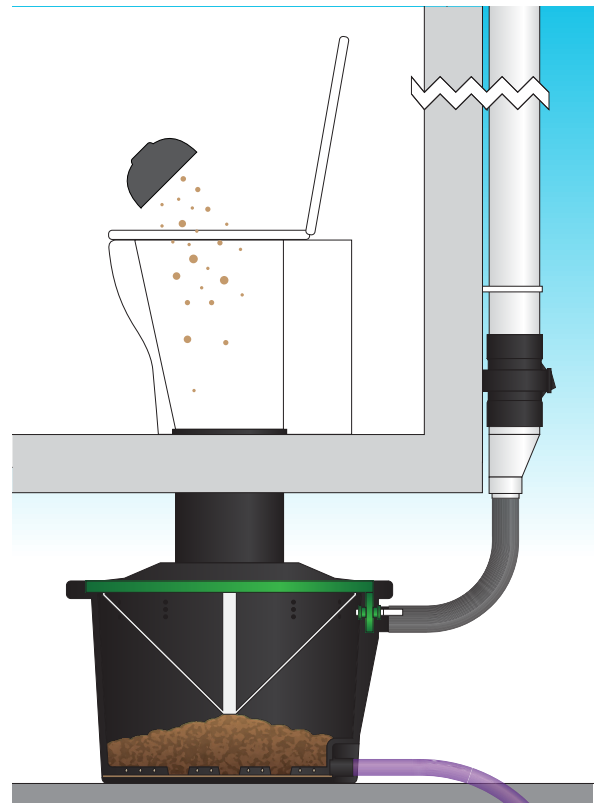

- 4** Repeat steps 1-3 each time you restart with an empty chamber.

# OPERATION

## AFTER EVERY LIQUID DEPOSIT

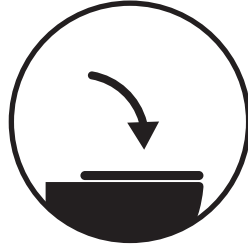

Close the lid

## AFTER EVERY SOLID DEPOSIT



Throw in a generous cup of bulking agent



Spray 10 squirts of enzymes around the bowl

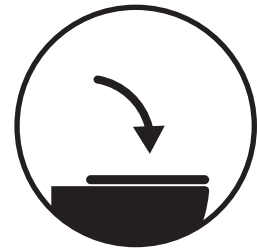

Close the lid

## DO NOT DISPOSE INTO THE COMPOST CHAMBER



Food waste



Chemical products or cleaning agents (including disinfectants)



Sanitary products and nappies

# ROTATING THE CHAMBERS

The chambers will need to be changed on a regular basis. A sufficient number of chambers must be purchased to allow the 'out-of-service' chamber a minimum of 6 months to compost (depending on the climate) from the time they are disconnected from the waste chute.

## Safety wear



When handling compost it is important to protect yourself from exposure to any potential pathogens. Wear safety materials such as gloves, long sleeves, goggles and a dust mask.

- 1** Pour a small bucket of bulking agent down the pedestal to cover up the waste pile before removing the full chamber.

Add an even 50mm starter bed of bulking agent to the next empty chamber for in-service use.

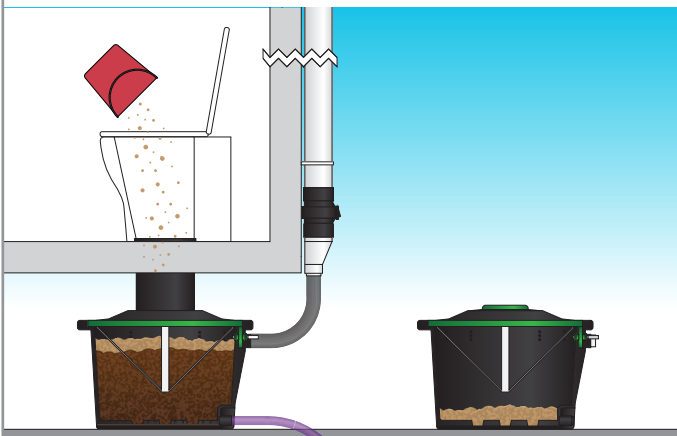

- 2** Disconnect the vent and drain system from the chamber, and immediately plug the liquid drain outlet with the dust plug. Lift the in-service lid up the chute and leave it there.

Remove the chamber from under the floor (if you have the Ezylift trolley, see next page).

Place the lid of the empty chamber onto the full chamber.

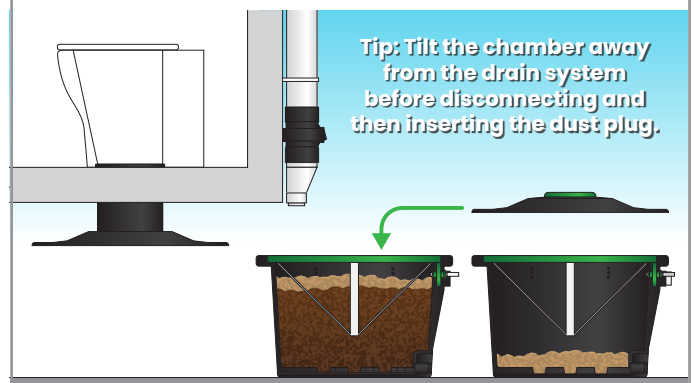

- 3** Place the new in-service chamber under the chute. Lower the lid and add the locking ring. Connect the vent and drain system.

Add the locking ring and lid plug to the out-of-service chamber.

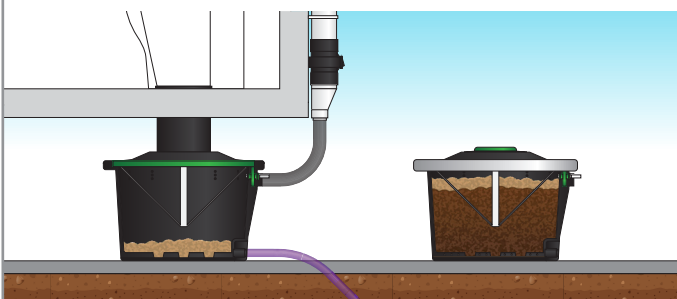

- 4** Add the Mozzie Stoppa to the out-of-service chamber. We recommend placing this chamber in a warm, sunny position until it has finished composting for a minimum of 6 months.

Optional: Remove dust plug to drain excess liquids.

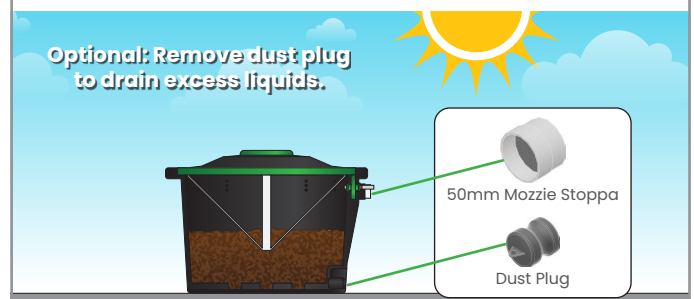

## Removing the Chamber with the EzyLift trolley (Only included in Premium package or purchased separately)

- 1** Add a cup of bulking agent down the chute. Unlock the chamber, unplug venting and plumbing, and slide the lid up the chute. Insert dust plug into camlock to prevent leaking during transport.

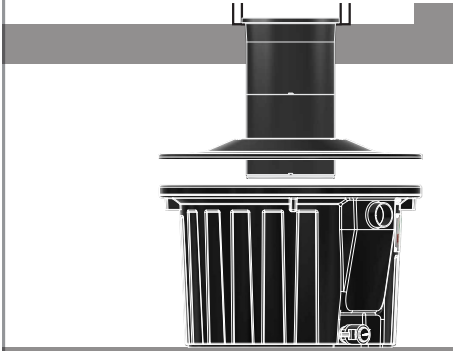

- 2** Access the chamber from the same side as the steel name plate. Slide the Ezylift trolley arms along the underside of the chamber until they catch on the Ezylock.

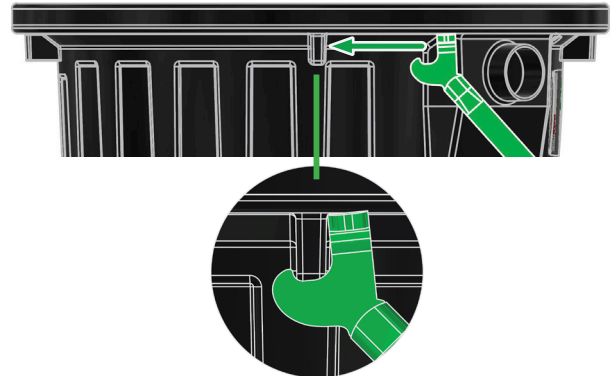

- 3** Slightly lift the chamber to remove it from under the chute. Keep the in-service lid attached to the chute.

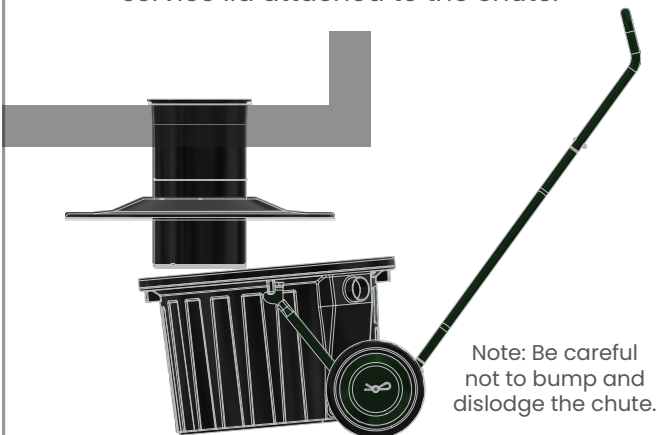

- 4** Add the out-of-service lid and locking ring. Place the out-of-service plug in the lid and lock it in place. Mix the chamber to distribute the pile.



- 5** Engage full height once clear of underfloor structure. The chamber will count balance and remain stable during transport.



- 6** Attach the 50mm Mozzie Stoppa to the vent outlet.

Optional: Remove dust plug to allow excess fluids to drain.





## How can I tell if my compost is ready?

The size of the pile should have reduced in size by approximately 20%. Finished compost should appear crumbly and moist (similar to fresh potting mix), not sodden or dry. It should not have any offensive odour, just an earthy one. Also, the pile should not be producing high heat any longer.

## What can I do with composted material?

The compost must be disposed of as per the local health department regulations. This normally means burying the compost 100mm below the surface of the ground so that it does not get moved around by people or animals walking over it. You could bury compost around fruit and nut trees, lawns, flower beds or shrubs.

Avoid contact with edibles such as vegetables, herbs, and plants for harvesting seeds (eg. sunflower, sesame). Although thermophilic composting reaches temperatures high enough to kill pathogens, we want to avoid any chances of contamination.

## Explanation of the Composting Process

The Alectura uses a natural aerobic process called Thermophilic composting. Basically, aerobic microbes, actinomycetes bacteria and fungi generate heat and break down waste into odourless compost that's safe to handle.

To explain it in detail, it begins with the piling and layering of waste and carbon-rich materials like wood shavings. Initially, mesophilic microorganisms break down easily decomposable materials, releasing energy in the form of heat. As the temperature surpasses 45°C (113°F), thermophilic microorganisms, including heat-tolerant bacteria and fungi, become dominant. These microorganisms rapidly decompose complex organic compounds, generating even more heat.

The sustained high temperatures in the thermophilic phase accelerates the breakdown of organic matter, kills pathogens, and promotes nutrient release. The compost pile naturally cools down after the thermophilic phase, allowing mesophilic microorganisms to continue decomposition at a slower pace.

For optimal performance, microbes require composting conditions that include:

- a minimum temperature of 12°C (54°F)
- Moisture content of about 70%
- 30:1 carbon-nitrogen ratio
- Oxygen/airflow

Microbes require a balanced diet of carbon and nitrogen to thrive and carry out their metabolic processes effectively. Simply put, carbon provides a source of energy, and nitrogen in the urine and faeces is for growth and metabolic activity.

# COMPOST ACCELERATORS

Whilst Nature Loo users report successful composting without the use of any additives, we strongly recommend the use of the following items in order to optimize composting, particularly when the toilet is in permanent use by more than two people.

## Bulking Agent

This should be added on a regular basis, preferably **a generous cup** after each solid use. Alternatively, if this is not possible, add the equivalent of this on a daily or weekly basis. The bulking agent can be added through the pedestal.

For best results use pine wood shavings or Hemp bedding found at your local hardware or pet store.

We do **NOT** recommend the use of:

- Sawdust as it creates as the small particles can create anaerobic condition within the chamber and small particles can disrupt ventilation.
- Cypress, cedar or eucalyptus wood shavings due to their antimicrobial properties.
- Sugar cane mulch as it makes using the mixer difficult. As well as any excess sugar leaching into the compost can attract bugs.



Wood Shavings



Hemp Bedding

## Liquid Enzymes

Enzymes are a natural detergent, that does not harm the culture of microorganisms in the compost pile. Dilute the concentrate to clean the toilet bowl and seat. The enzymes act as catalysts, breaking down grime and mineral deposits into their basic elements, and helping to accelerate the composting process.



## Microbes

Microorganisms aka microbes are the ones doing the composting in your toilet. Each microbe packet is full of aerobic microbes, actinomycetes bacteria and fungi which combine with the natural bacteria in the waste to convert into nutritious fertile compost. Refer to instructions on packet for directions on usage.

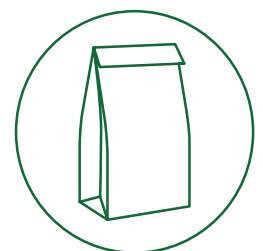

Page intentionally left blank to be teared off

# MAINTENANCE SCHEDULE

Please place this maintenance schedule close to your 'In-service' Chamber and complete the table as you rotate your chambers.

Model: \_\_\_\_\_

Date first put into service: \_\_\_\_/\_\_\_\_/\_\_\_\_

The 'Out-of-service' chamber must compost for a minimum of 6 months from the date it was first rotated 'Out-of-service'.

## Date chambers were last rotated:



Wear protective clothing including gloves and eye wear when servicing, rotating or emptying chambers.

# MAINTENANCE

## Daily or Weekly

- Clean restroom and toilet fixtures using only biodegradable cleaners (enzymes)
- Add 1 cup of bulking agent to toilet after every solid use

## Fortnightly

- Mix the composting pile using the mixer or using a rake to turn over the 'cone' inside the in-service chamber.

## Monthly

- Inspect the 'In-service' chamber. Depending on usage, prepare an empty chamber for use once the chamber becomes full (refer to Rotation of Chambers, page 21)
- Check vent pipe and remove any foreign matter
- Check the fan is operating
- Check that the system is draining correctly
- Remove and clean the fan and fan mesh. Ensure the fan is free of dust and moving easily

## Tips

- Carry a spare fan
- Periodically check your drain hose (aka excess liquids hose) for blockages. Wear protective clothing and gloves. To check if there is any blockage around the drain outlet under the perforated false floor, disconnect the drain hose from the chamber and pour hot water in the chamber. To check if there is any blockage in the drain hose, pour hot water down the hose.



It is important to observe safety procedures when dealing with fresh human waste.

Please ensure you wear protective clothing (gloves and old clothes).

Do not attempt to move the chambers on your own unless assisted by another person or using the Ezylift.

# TROUBLESHOOTING

Nature Loo toilets have proven themselves to be one of the easiest systems to manage. However, being a natural process, reliant on a number of factors beyond our control, it can occasionally need some help to maintain an appropriate balance.

## The 'in-service' chamber is filling too quickly

This may be caused by a number of factors:

### THE PILE IS NOT COMPOSTING DUE TO INCORRECT START-UP

Ensure a 50mm high layer of bulking agent wet with water is added to the chamber and the starting microbes are added.

### THE TEMPERATURE IS TOO LOW FOR EFFECTIVE COMPOSTING

Try to insulate the chamber. Less technical ways of doing this over winter are by (a) creating a box with hay bales and lid with an up-cycled window arrangement, (b) wrapping the chamber in insulating material like a yoga mat or bubble wrap, or (c) placing the chamber in a pop-up greenhouse. Additionally, reduce airflow during winter months by adjusting the fan voltage on the transformer if possible.

### INSUFFICIENT AIR FLOW

This can be caused by a broken fan or the chamber being too full. Check the fan is operating and the level of the pile is not too high. This problem could also be caused by a blocked insect screen in the vent cowl. Check that the fan mesh in the fan housing is not blocked.

### THE PILE BEING TOO WET

This could be the result of the outlet of the liquid chamber being blocked and causing the upper chamber to flood. Check the drain hose is not blocked and flush with a hose if necessary. You may need to change chambers if the blockage is in the chamber and thoroughly flush out the contents of the liquid chamber.

### ANTIBIOTICS AND DISINFECTANTS WILL SLOW DOWN OR STOP THE PROCESS

Restart the composting by reintroducing microorganisms (microbes). In many of these situations enzymes will help solve inefficient composting by breaking down the solids and thereby speeding up decomposition. Ensure you are not introducing any antibacterial or antimicrobial matter or cleaning disinfectants to the compost pile.

## The mixer does not rotate

The pile should contain around 65% of moisture. Toilet paper should break down. If not, the pile is too dry. A pile that is too dry can cause hard lumps that could block the mixer ring from turning. Pour some water over the pile to add moisture. Ensure the mixer cog and bushing is installed correctly.

## The 'out-of-service' chamber is composting too slowly

This may happen due to one or more of the problems described in the previous page. At this point the most effective course of action is to aerate the pile by turning it over with the Compost Mixer. You could also add compost accelerator as you turn the material and add a quantity of microbes.

You should consider locating the chamber where it has a greater exposure to direct sun light. If you find the pile is drying out too quickly, add water.

If you find none of the above measures are effective, it means the local climatic conditions are less than ideal. This can happen in cold or humid conditions and you will need to purchase additional chambers in order to provide an extended composting period, or a heating belt to keep the chambers warm.

If you need to change your 'In-service' chamber but the 'Out-of-service' chamber is not yet composted, dispose of the waste as normal and order an extra chamber from your place of purchase.

## The odour from the 'out-of-service' chamber is unpleasant

This may happen immediately after the chamber has been taken 'Out-of-service'. Odours can be greatly reduced or eliminated by covering the top of the pile with bulking agent, straw or dry grass clippings. You may wish to do this before disconnecting the chamber. Also check that the pile has the correct moisture content.

## The odour from the 'in-service' chamber is unpleasant

If this is not caused by a failed fan, or blockage in the vent pipe, liquid drain hose or fitting, please see the "In-service' chamber is filling too quickly" section for how to resolve this problem.

## The power has failed resulting in toilet room odours

Cover the pedestal with cling film until the power is restored. If you are connected to mains power consider installing an Uninterrupted Power Supply (UPS), available at Ecoflo. The UPS will cut in with power from a 7Ah battery when there is a loss of mains power.

### Helpful hints from our customers:

- Paint the Vent Stack black to produce an upward air flow.
- Add a wind assisted turbo vent to the Vent Stack.



Find more Troubleshooting and FAQ information online at [ecoflo.com.au/FAQ](https://ecoflo.com.au/FAQ) or email us at [info@ecoflo.com.au](mailto:info@ecoflo.com.au)

# PRODUCT & COMPONENT WARRANTY

Ecoflo will furnish new parts to a customer whose toilet fails within the allotted warranty period for the particular component, provided that our inspection shows such failure is due to defective material or workmanship. Any part supplied is warranted for the balance of the original warranty period. The warranty period for a part begins from the date the original product was dispatched (plus 10 working days for transportation).

## Warranty Period:

Any electrical component including solar	1 year
Any moulded component	10 years
Any porcelain/polymarble component	4/5 years
Toilet seats	1 year
Any other component	1 year

## This warranty does not cover

- Damage resulting from neglect, abuse, accident or alteration; or damage caused by fire, flood, acts of god or other causality.
- Damage resulting from failure of the purchaser to follow normal installation and operating procedures outlined in the manual or in any other printed instructions supplied with the system.
- Labour and service charges incurred in the removal and replacement of any parts found defective under this warranty.

Items subject to a dispute, where photographic evidence is inconclusive, must be sent prepaid to Ecoflo. The cost will be reimbursed by Ecoflo should the claim be found valid.

In addition to the above, Ecoflo will only replace a fan that fails during the warranty period under the following conditions:

- The fan has only ever been connected and powered by either a 12 volt transformer plugged into mains power or a solar system supplied by Ecoflo. Connecting your fan directly to a power source other than one supplied or specified by Ecoflo may result in damage to the fan and void the warranty.
- The fan and transformer must not be modified/altered in any way.
- The faulty fan is returned to Ecoflo for inspection, if required.

Providing the above conditions have been met replacement fans are shipped the same or following day free of charge by regular post.



# CONTACT

The place of purchase is responsible for handling warranty claims and addressing product concerns during the warranty period.

## AUSTRALIA



Ecoflo Wastewater Management

[ecoflo.com.au](http://ecoflo.com.au)

PH 1300 138 182 or (07) 3889 6144

[info@ecoflo.com.au](mailto:info@ecoflo.com.au)

Available Monday - Friday (excluding public holidays)

## NEW ZEALAND



Waterless Composting Toilets NZ

[wctnz.co.nz](http://wctnz.co.nz)

PH 0800 022 027

[sales@wctnz.co.nz](mailto:sales@wctnz.co.nz)

## USA



Nature Loo

[natureloo.com](http://natureloo.com)

[info@natureloo.com](mailto:info@natureloo.com)

## CANADA



Nature Loo

[natureloo.ca](http://natureloo.ca)

[info@natureloo.com](mailto:info@natureloo.com)



Proudly Designed in Australia by  
Ecoflo Wastewater Management





