



PS System

Above Ground Plug & Play Series

OIM Manual ***Operation - Installation - Maintenance***



- GFPS-AG manual filtration - 100W (GFPS-AG-M1)
- GFPS-AG manual filtration - 300W (GFPS-AG-M3)
- GFPS-AG manual filtration - 400W (GFPS-AG-M4)

- GFPS-AG automatic filtration - 100W (GFPS-AG-S1)
- GFPS-AG automatic filtration - 300W (GFPS-AG-S3)
- GFPS-AG automatic filtration - 400W (GFPS-AG-S4)



"moving water"

www.greyflow.net.au

Contents

Contents:

OPERATION:

Selection & Operation	Page 2
Requirements	Page 3

INSTALLATION:

Parts list & Components	Page 4
Important Do's and Don'ts	Page 5
Operating Modes - Manual System	Page 6
Operating Modes - Automatic System	Page 7
Plumbing and power connection	Page 8
Installing the irrigation system	Page 9 - 10

MAINTENANCE	Page 11
--------------------	---------

TERMS OF WARRANTY	Page 12
--------------------------	---------

DISCLAIMER	Page 13
-------------------	---------

"moving water"

www.greyflow.net.au

Selection and Operation

Congratulations, You've taken an important step towards environmentally friendly living with your purchase of the Grey Flow PS above ground Plug & Play greywater diversion and reuse system.

The Grey Flow PS Plug & Play was developed for above ground / partially buried installations and can be retrofitted into almost any house

Please note: Due to its high fat content water from Kitchen can be harmful to soils and should only be reused after the water has passed through a grease trap or grease arrestor.

Manual diversion of the greywater to sewer is achieved by turning off the manual valve separating the interceptor from the tank, or by turning off the power supply to the unit

"moving water"

www.greyflow.net.au

Requirements

- The water discharge should be kept below mulch or soil (check for local state, municipal & council laws and regulations)
- 220 Volts power supply should be available
- Any PVC plumbing connections should be performed by a license plumber
- The Grey Flow PS must be turned off during wet conditions and any sign of accumulation or run-off
- All minimum irrigation areas and set back distances must be in accordance to local regulations
- Table 1.0 provides an estimated average volume of greywater that is generated in various parts of the house. Refer to your greywater state guidelines to evaluate your minimum requirements.

Table 1.0

Number of Bedrooms In the House	Assumed Number of People	Quantity of Grey Water Generated in L/day		Soil Types	Minimum Garden Area In Square m		Recommended Maximum area In Square m	
		Laundry Only	Whole of House		Laundry	House	Laundry	House
2	3	120	300	Sandy	12	30	24	60
				Loamy	18	45	36	90
				Clay	24	60	48	120
3	4	160	400	Sandy	16	40	32	80
				Loamy	24	60	48	120
				Clay	32	80	64	160
4	5	200	500	Sandy	20	50	40	100
				Loamy	30	75	60	150
				Clay	40	100	80	200
5	6	240	600	Sandy	24	60	48	120
				Loamy	36	90	72	180
				Clay	48	120	96	240
6	7	280	700	Sandy	28	70	56	140
				Loamy	42	105	84	210
				Clay	56	140	112	280
7	8	320	800	Sandy	32	80	64	180
				Loamy	48	120	96	240
				Clay	64	160	128	320

Parts List

Manual Option (M1, M3, M4)

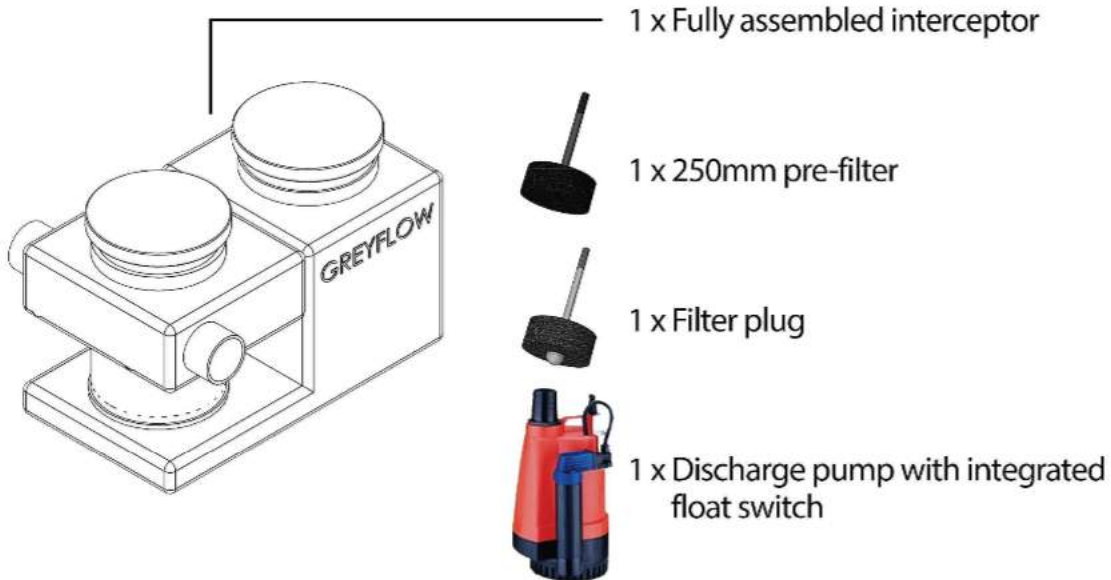

Automatic self-cleaning option (S1, S3, S4)

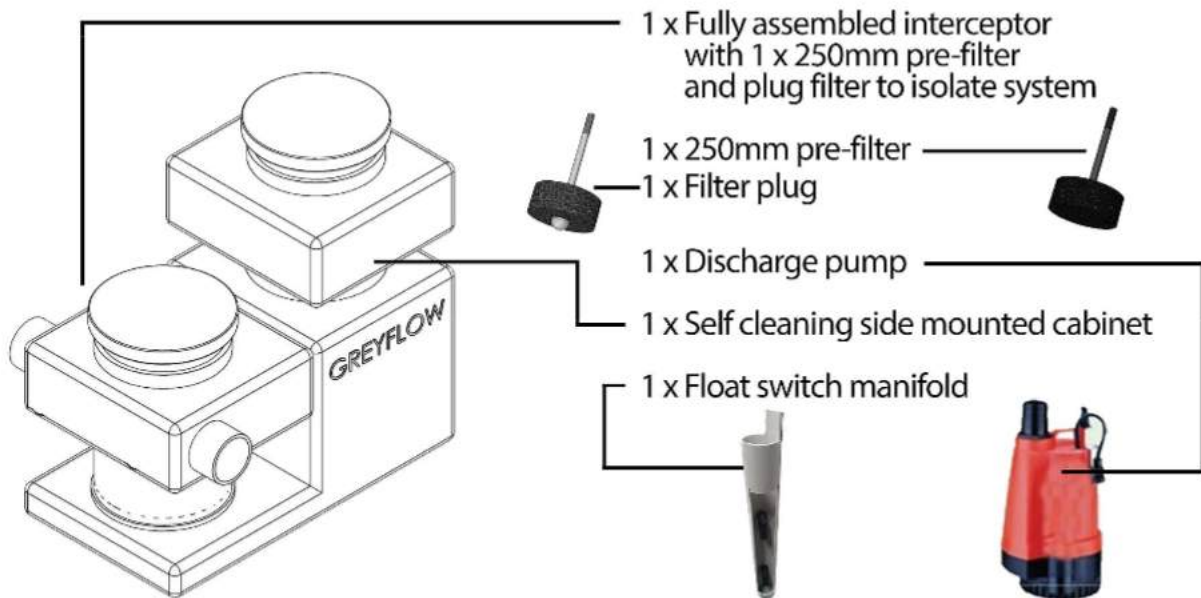

Important Do's and Don'ts

To shut down the greywater system insert the filter plug all the way down the interceptor

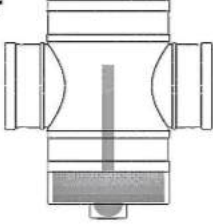

To start using the greywater system make sure to replace the filter plug with the standard filters

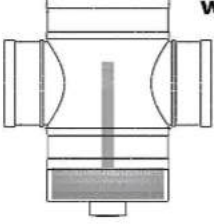

Never operate the system without the lint filters



Above ground systems and partially buried systems should never be buried beyond the indicated level below.

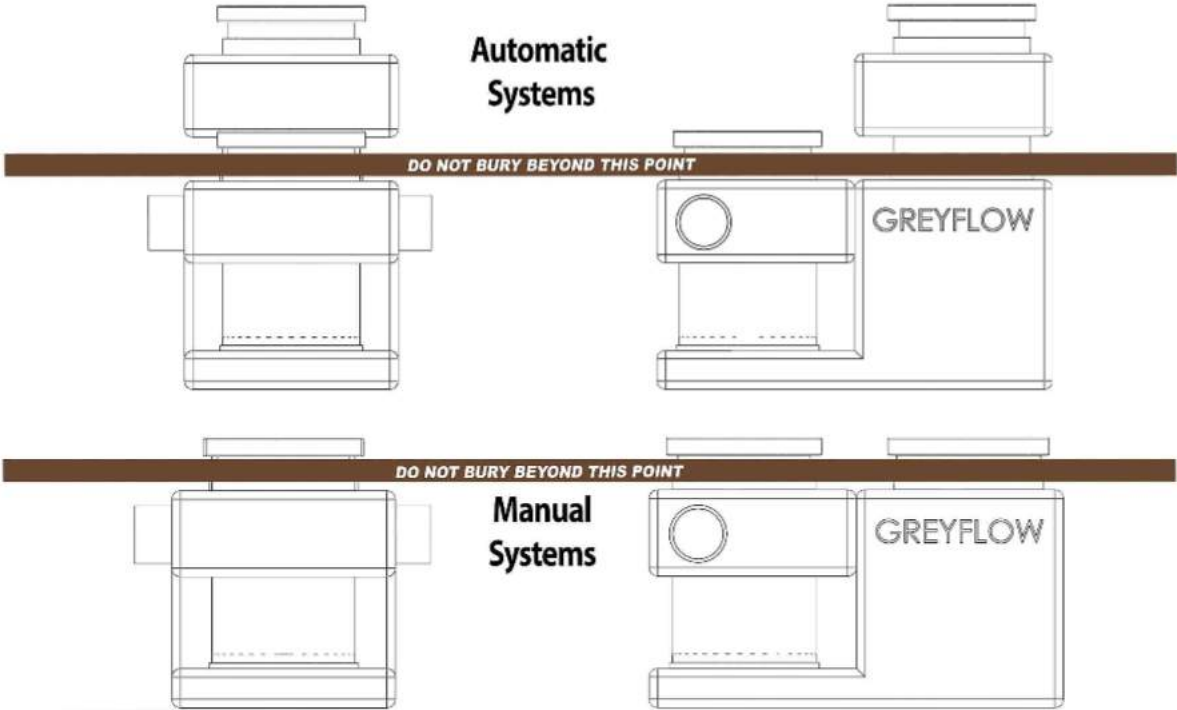

Operating Modes - Manual System

Shut off mode

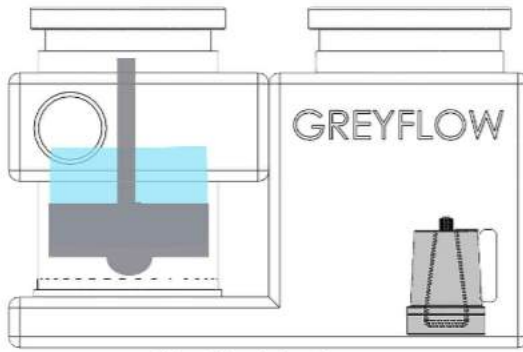

Plug filter is in place

Water enters the system from the entry pipe, and overflows via the overflow pipe. Float switch integrated on the pump is not activated

Standby mode

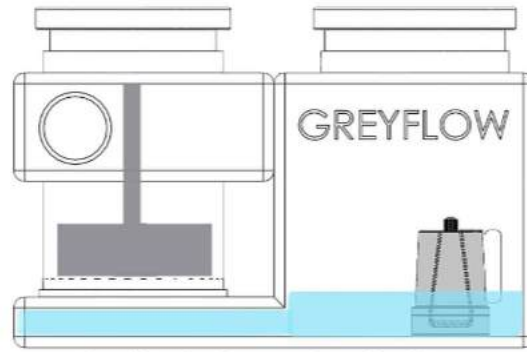

Plug filter has been replaced by filter

Water level in the main pit is below the float switch level. Float switch integrated on the pump is not activated

Operating mode

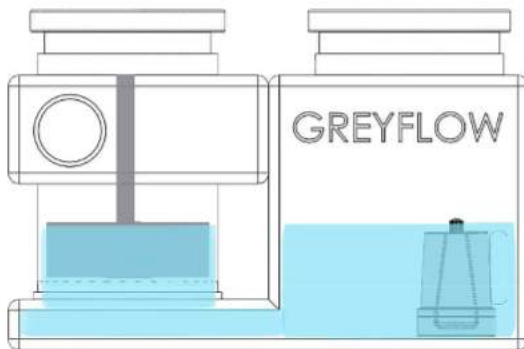

The pump is activated when the integrated float switch is lifted by the raising water in the tank. The pump is deactivated when water level is below the float switch

"moving water"

www.greyflow.net.au

Operating Modes - Automatic System

Shut off mode

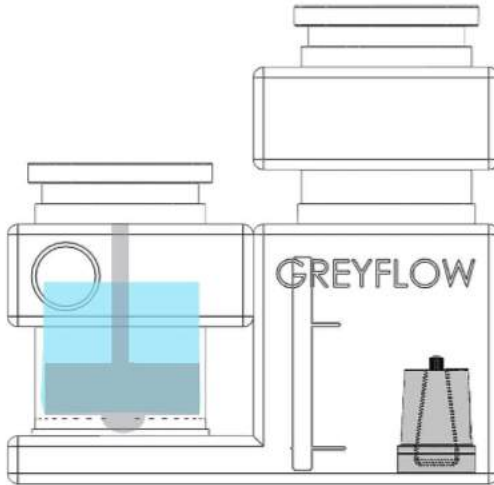

Plug filter is in place

Water enters the system from the inlet pipe, and overflows via the overflow pipe

Standby mode

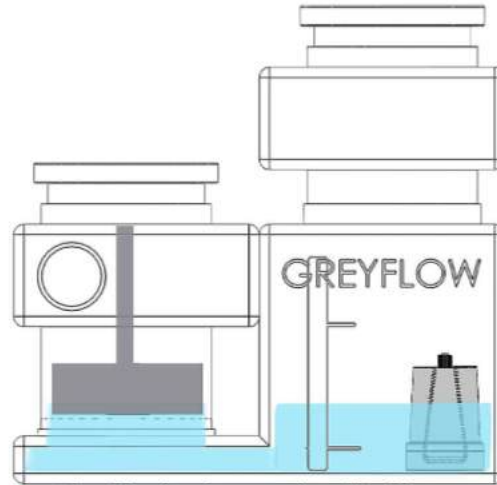

Plug filter has been replaced by filter

Water level in the main pit is below the upper float switch level. The pump is not activated.

Operating mode

The pump is activated when the water level reaches the upper float switch. The pump is deactivated when the water level drops below the lower float switch

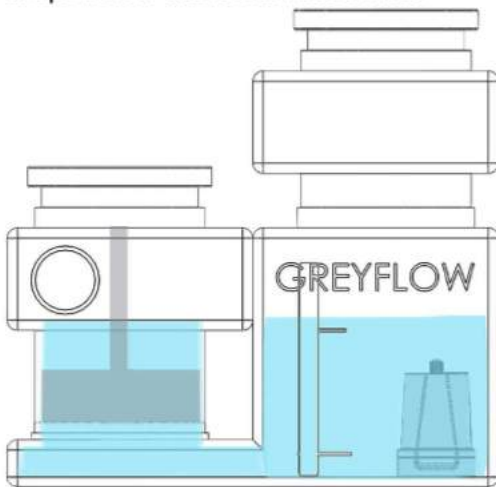

Backflush mode

Water enters the system, backflush mechanism cleans the filters with compressed air

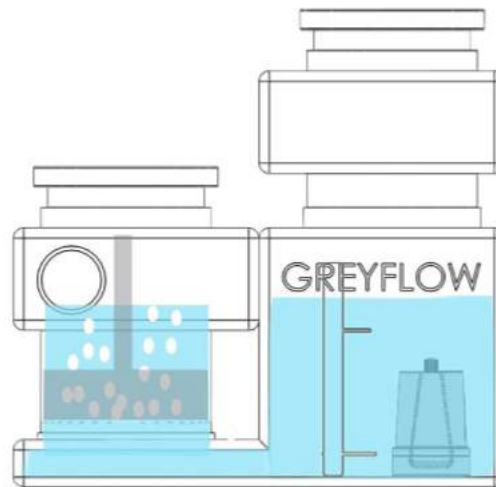

"moving water"

www.greyflow.net.au

Plumbing and power connection

Inlet and overflow pipe are reversible

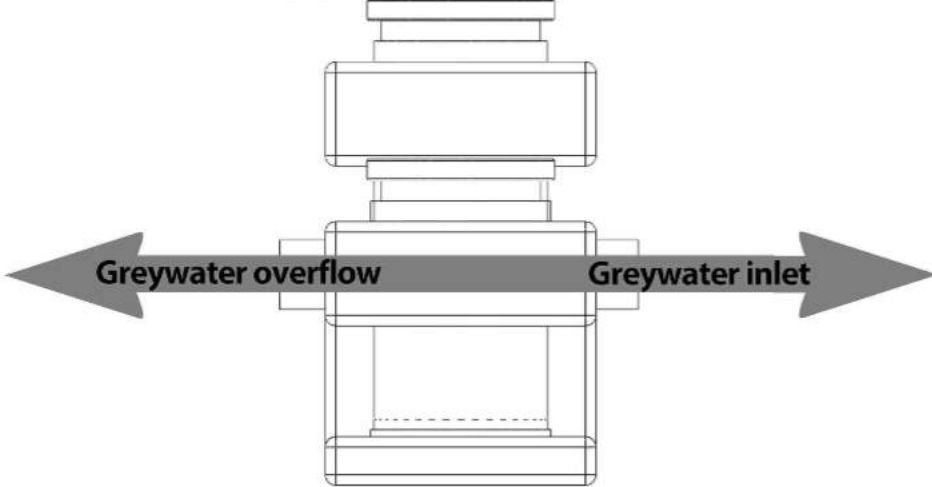

Power connection

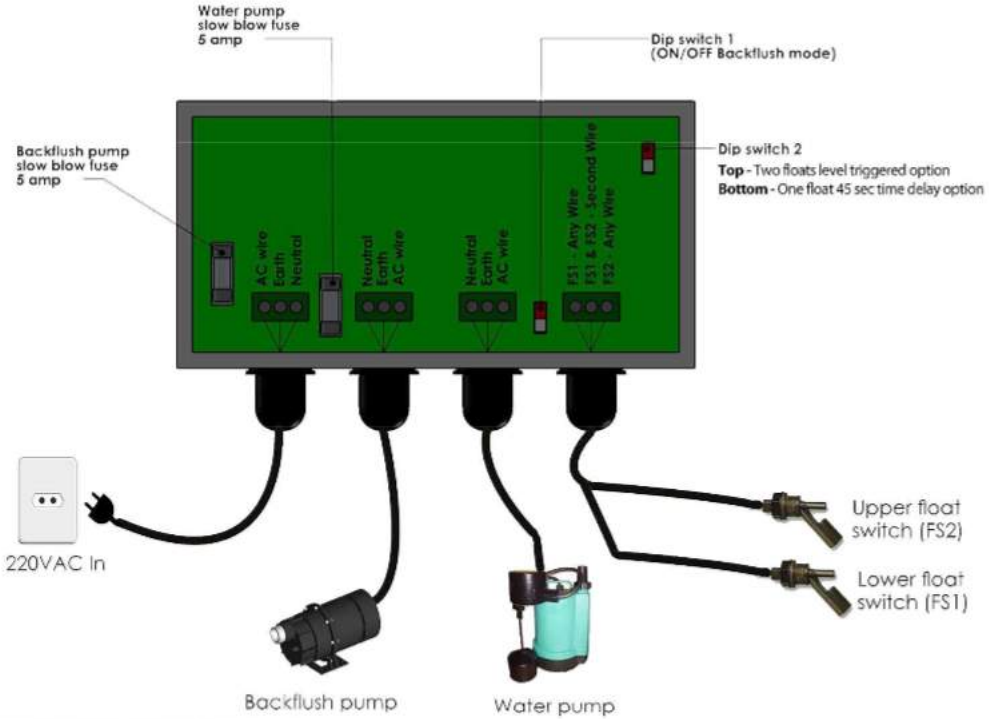

TYPICAL IRRIGATION LAYOUT

100m of Dripline is used in the following layout

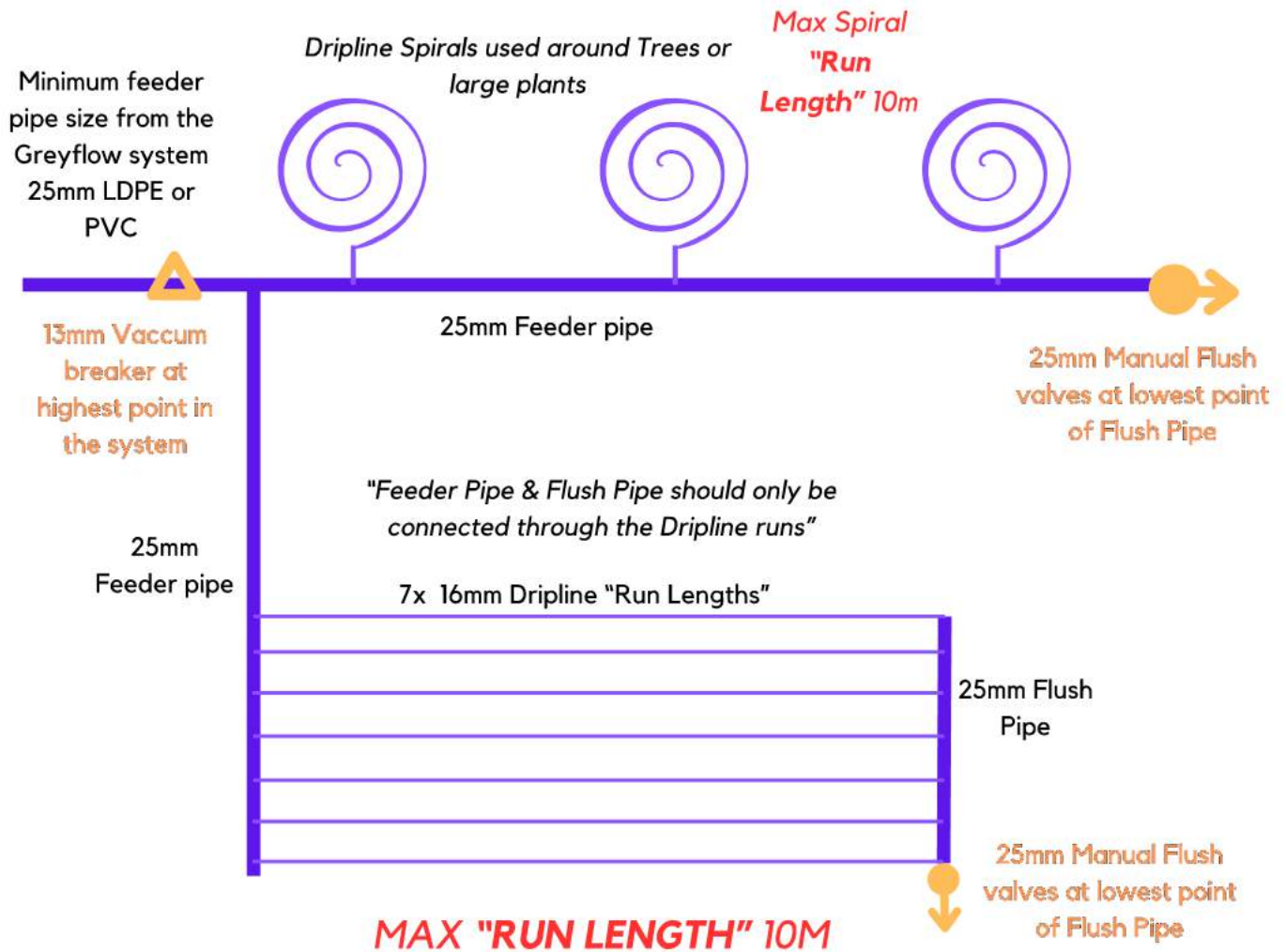

THE FOLLOWING WILL VOID THE WARRANTY OF THE GREYFLOW SYSTEM:

1. THE USE OF A NON GREYFLOW DRIPLINE TUBE
2. THE USE OF A FEEDER PIPE SMALLER THAN 25MM
3. RUNNING LESS THAN 80M OF DRIPLINE AT ONE TIME
4. DRIPLINE "RUN LENGTH" LONGER THAN 10M LONG

GREYFLOW IRRIGATION EQUIPMENT AVAILABLE

Complete Dripline Kit:

- 50m of 25mm LDPE
- 100m of 16mm Dripline 8L/Hr emitters @ 0.3m spacing
- 8mm punch tool
- 25x (8 x 16mm) elbow take offs
- 2x 25mm Joiners
- 2x 25mm End Plugs
- 2x 25mm Elbows
- 25mm Tee
- 25mm Nut and Tail
- 14x 25mm Ratchet Clamps



Dripline Station Kit:

- 100m of 16mm Dripline 8L/Hr
- 8mm Punch Tool
- 25x (8 x 16mm) elbow take offs



6 Station Rotor Valve:

- 50 & 100L Volumetric Indexing valve for up to 6 stations



25mm Flush Valve:

- The Valve will assist in the regular recommended flushing of the dripline



1/2" Air Vacuum Breaker:

- To be located at high points within the system and prevent vacuum within the pipe network. Vacuum causes drippers to suck air & dirt



25mm Spring Loaded Check Valve:

- A Spring Loaded Check Valve is used in the feeder pipe in sloping grounds to prevent excessive drainage to the lower points and allow for a more balanced water distribution



Installing the Irrigation System

Option 2: Multi station distribution using GF Rotor

Use GF Rotor flow based indexer to split the system into more than one station. Up to 6 stations.

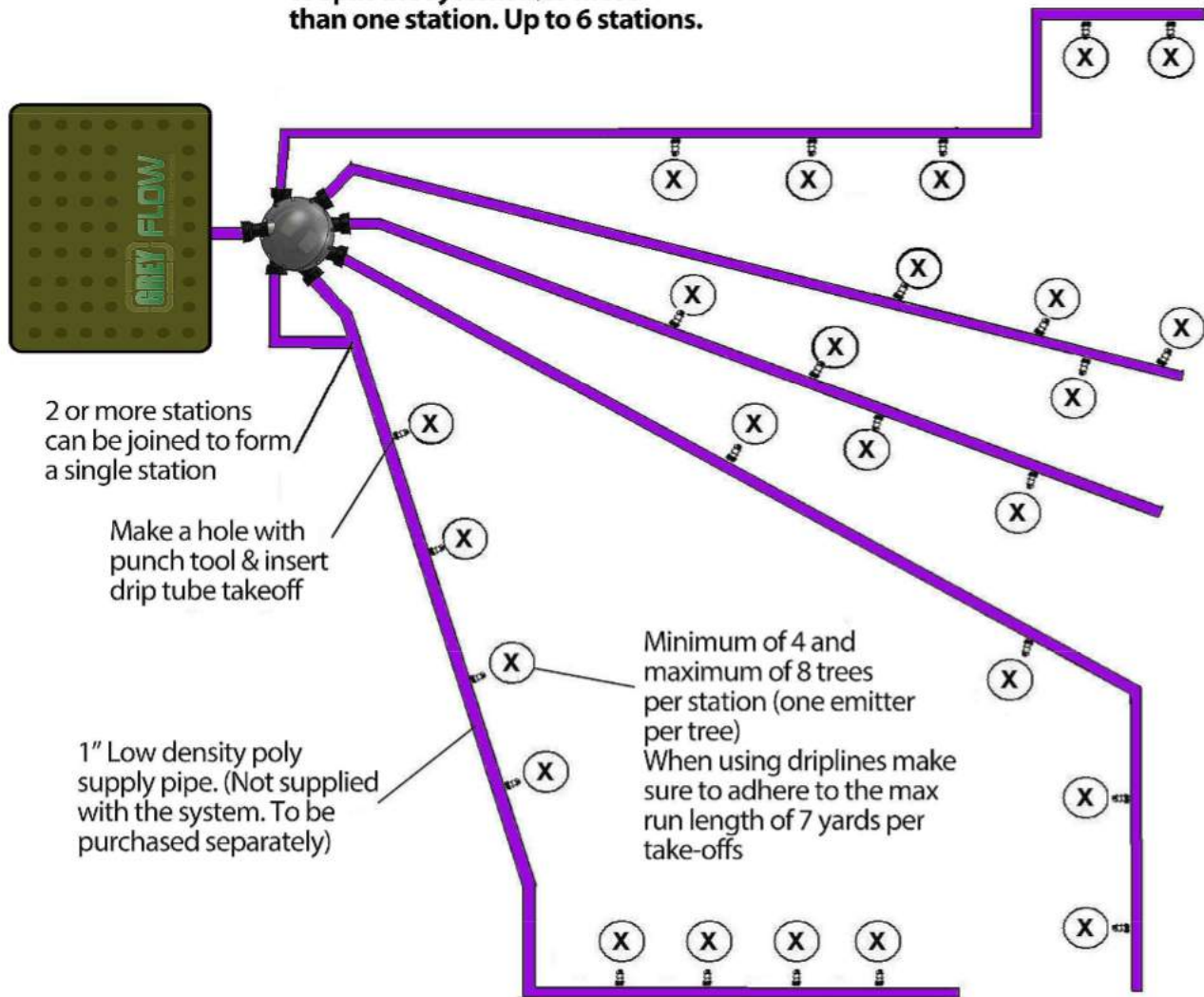

Grey Water Warning Sign to be visible at all times

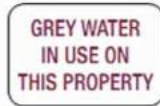

Maintenance

To retain the original reliability and performance of the GFPS System the following maintenance procedure should be followed. Please ensure that you wash your hands thoroughly after contact with greywater or handling any part of the GFPS System.

The following maintenance steps should be carried every year and not less than once every 2 years:

- Open top cover of the GFPS Tank
- Remove the filters and wash thoroughly in a bucket, with a garden hose or in any basin not connected to the dedicated grey water line.
- Wash thoroughly the tank, the pump and the float switch with a garden hose.
- Disconnect the GFPS pump and connect directly the scheme water supply to the pump discharge
- Flush the greyflow emitters with fresh water for about five minutes.
- Re-insert the filters to their original position, close the lid of the tank and the system is ready to operate again.
- Top up mulch over the Grey Flow emitters to a minimum depth of 2".

Limited Consumer Warranty

ADVANCE WASTE WATER SYSTEMS

Two Year Limited Warranty

Advance Waste Water Systems (AWWS) warrants this product against material defects in materials and workmanship for a period of TWO YEAR from the date of the original retail purchase (warranty period). Warranty work will be done in accordance with the following terms and conditions. This warranty only benefits the original purchaser.

THIS WARRANTY COVERS ONLY DEFECTS IN MATERIAL AND WORKMANSHIP. THIS WARRANTY DOES NOT COVER ANY OF THE FOLLOWING:

1. Expendable items that can wear out from normal use, including but not limited to, filters, or similar perishable parts.
2. Damage to or failure of this system if it is not installed, operated, or maintained according to all instructions supplied with the system.
3. Damage to or failure of this system resulting from accident, abuse, misuse, or use for other than its intended purpose, Act of God.
4. Damage to or failure of parts or system resulting incomplete or improper installation or from unauthorized modifications made to this system.
5. If you purchase the system from an unauthorized retailer or dealer.
6. Damage caused by power surges, electrical storm damage, incorrect power supply, or insect or vermin infestation
7. Damage to or failure of parts if this system is serviced or repaired by anyone other than an Authorized Service Center.
8. This warranty extends only to you, the original purchaser. It is not transferable to anyone who subsequently purchased this product from you.
9. Use for more than a single family or use in a commercial establishment or for commercial non-household purposes.
10. Parts and systems not supplied by AWWS are not covered by this warranty

Any item which has been repaired or replace under this warranty shall be covered for the remainder of this original warranty as extended by the number of days that the product has been out of your hands for repair.

Disclaimer

Disclaimer of implied warranties; Limitation of remedies

1. All implied warranties, including implied warranties of merchant ability and fitness for a particular purpose, are limited in duration to one year from the date you purchased the product.

2. Neither AWWWS nor its affiliates are responsible or liable for any loss, inconvenience or damage, whether special, exemplary, direct, incidental, consequential or otherwise, and whether known or should have been known to AWWWS including damage to or replacement of other equipment and property and personal injury resulting from any breach of warranty, the inability to use the product or under any legal theory in contract or tort. These warranties and remedies are the sole and exclusive warranties and remedies given by AWWWS in connection with the sale and use of the product. No other warranties, oral or written, express or implied are given.

3. In any event, AWWWS's entire liability shall be limited to the actual purchase price you paid to the retail seller of the defective product. This limitation applies whether damages are sought or a claim made, under this warranty or as a tort claim (including negligence and strict product liability), a contract claim or any other claim. This limitation cannot be waived or amended by any person. This limitation of liability is effective even if AWWWS or any authorized representative of AWWWS has been advised by you of the possibility of such damages. This limitation of liability, however, shall not apply to claims of personal injury.

4. No AWWWS dealer, agent or employee is authorized to make any modification, extension, change or amendment to this warranty.

YOUR RESPONSIBILITY

The above limited warranties are subject to the following conditions:

You must provide your original bill of sale, invoice or other proof of purchase of the system showing that you are the original purchaser, that the purchase was made within two years of the date of your claim and that you purchased it from an authorized dealer or retailer. No warranty work will be done without this information. Keep a copy of your receipt or invoice for your own records. These limited warranties are effective only if this system is purchased and used in AU region. Labor and service charges for warranty repair, installation, set up, and adjustment of customer control are not covered by these limited warranties. Should you encounter a defect in the system, www.greyflow.net.au to find the closest authorized service center. Contact the center and it will arrange for an inspection and corrective action, if needed and if covered by this warranty.

Should the center determine that the system is not covered by this warranty; any corrective work will be performed at your request and at your expense. If the center makes a second and/or subsequent visit and determines that there is no problem or that the system is not covered, the service call will be charged to you.

When making a warranty claim, please be prepared to provide a description of the system, your name, address, work day telephone number, a description of the problem, the date you purchase the system and the identity of the seller.

"moving water"

www.greyflow.net.au



Advance Waste Water Systems Pty Ltd

P.O. Box 561, Floreat, WA6014

Mob: 04-0545-9533

Tel: 08-9467-5990

Fax: 08-9309-2304

Email: sales@greyflow.net.au

www.greyflow.net.au

"moving water"