

# Separera *mini*



URINE CONTAINER

User Manual

# Table of Contents

---

SEPARERA MINI WITH URINE CONTAINER	1
Contacting Environmental Health	1
Inside the Separera box	1
Vent Installation Kit	1
Separera Mini cross section	1
INSTALLATION	2
Tools	2
Air supply	2
Assembly	2
Step 1 - Base unpacking	2
Step 2 - Ventilation pipes through the wall or roof	2
Step 3 - Ventilation pipes above the roof	3
Step 4 - Fastening base and connecting to power	3
MAINTENANCE	4
Solid waste	4
Urine container	4
Electrical connection	4
General advice	4
CONTACT	5

# Separera Mini with Urine Container

---

This urine separating toilet is constructed from eco-friendly material and is designed to cope with high demand over many years. What does separating waste mean? Well, the toilet is designed so solid waste is separated from the liquid (urine). This means that the Separera Mini has two containers, one for urine and another for solid waste. Both must be dealt with in accordance with local regulations.

## Contacting Environmental Health

Contact Environmental Health office regarding local health regulations. This applies when installing any type of toilet.

## Inside the Separera box

- Toilet with fan
- Lid
- Screws, washers, anchors
- Ventilation Pipe 50 cm for wall
- Insect netting
- 2 Solid waste containers
- 1 Urine container
- Bio bags
- 125ml Nature Flush enzymes
- 750ml Spray bottle
- 12V Power adapter/transformer

## Vent Installation Kit

- Ventilation pipes (4x1.1 m ventilation pipe with 55 mm outer diameter)
- Exterior pipe (1x 1.1m with 110 mm outer diameter)
- Insulation (2x 1m)
- Reducing coupling
- Roof flashing
- Insect netting
- Pipe bend 90°
- Wall bracket
- Screws, washers, bolts, nuts, anchors

## Separera Mini cross section

1. Fan motor
2. Socket for adapter/transformer
3. Solid waste container with a bag
4. Toilet seat, soft close
5. Top
6. Base
7. Chamber screen
8. Urine container

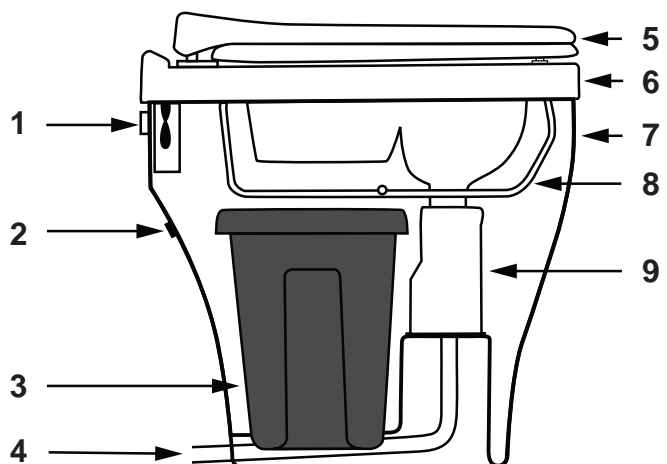

# Installation

## Tools

- Drill
- Holesaw for 55mm hole
- Silicone
- Jigsaw/handsaw

## Air supply

Make sure there is a good air supply, for example, through a 10 mm gap under the door or a vent. Air will be evacuated through the toilet, cross-draughts must be avoided.

## Assembly



### Step 1 - Base unpacking

1. Lift off the top (5) of the toilet, remove the urine container (8) and waste container (3).

### Step 2 - Ventilation pipes through the wall or roof

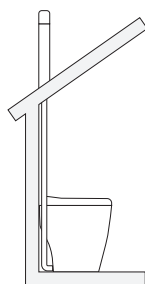

#### Option A - Through Roof

1. Fasten the wall bracket temporarily on the base (6).
2. Put the base in position against the wall. Mark for the bracket.
3. Remove the wall bracket from the toilet. Install the bracket on the wall.
4. Set the base in position and mark where the screws go to fasten it to the wall.

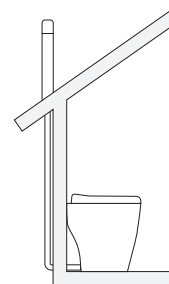
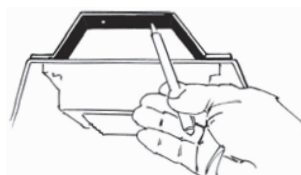
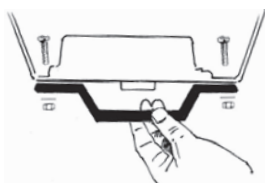

#### Option B - Through Wall

1. Place the base against the wall, and mark the hole for the ventilation pipe. Cut the hole with a holesaw (55mm).
2. Temporarily attach the 50cm long pipe to the outlet on the base, and place it in position to mark how much excess pipe to trim off (keep at least 5cm past the wall for the 90° bend to attach to). Trim pipe with a jigsaw or handsaw.
3. Keep the base in position and mark where the screws go to fasten it to the wall.

### Step 3 - Ventilation pipes above the roof

1. Make a hole in the roof for the ventilation pipe, 55 mm.
2. Put the 90° bend on the ventilation pipe or outlet.
3. Attach the ventilation pipes unsleeved end into the 90° coupling.
4. Insulate all piping that passes through cold spaces (e.g. in the attic and on above roof). This is to prevent condensation.
5. Cut the exterior pipe to fit the angle of the roof.
6. Position the roof flashing. For tin roof, its better to have a sheetmetal worker to make the flashing.
7. Put the outer pipe with the roof flashing over the insulated ventilation pipe.
8. Adjust the roof flashing to the external roof and seal firmly with asphalt sealant between the flashing and the roof.
9. Once all the piping is insulated and covered, fit the reducing coupling on top, and then fit the insect netting.

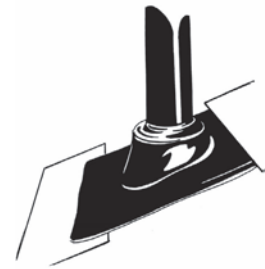

### Step 4 - Fastening base and connecting to power

1. Fasten the toilet securely to the wall or bracket using screws and washers.
2. Place a bag in the composting chamber and fold it over the edge. Put the frame in position to lock the bag.
3. Place the container inside the base and make sure that the bag does not cover the fan.
4. Put the top back in place.
5. Connect to power.
6. Check that the Separera logo is turning green to confirm that the urine container is in correct position.

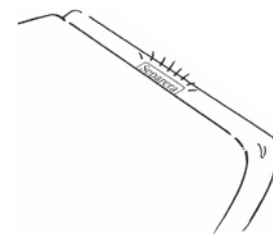

# Maintenance

---

## Solid waste

With normal use, a family of four produces around 7 litres of solid waste per week. The emptying frequency depends on usage. For example, after 2-3 weeks use by 4 people it will be time to switch composting chambers.

Simply remove the top, tie up the bag, remove and replace it with a new bag.

If you would like to compost the waste and use as a fertiliser, we recommend emptying the waste into a separate external chamber, adding a little bulking agent, and setting it aside in a shady place to complete composting (this make take around 6 months, depending on conditions).

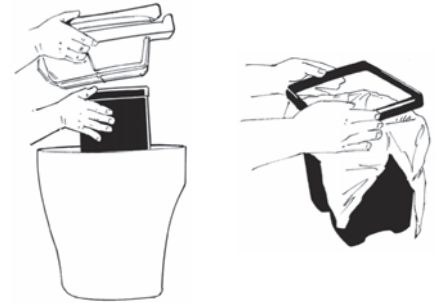

## Urine container

When the urine container is full the lamp will change from green to red.

1. Disconnect the power
2. Lift the top (5) of the toilet
3. Lift the urine container (8)
4. Empty
5. Rinse the container with hot water
6. Return container and connect to power. Check that the Separera logo is green to confirm that the urine-container is in correct position.

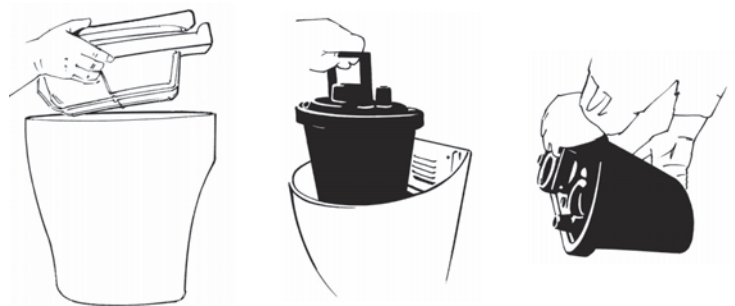

## Electrical connection

Separera is approved for installation in wet rooms.

## General advice

- Empty the solid waste regularly, the bags start to decompose after 2-3 week.
- If insects get into the toilet, refer to our information on dealing with insects that can be found in the troubleshooting section of our website ([ecoflo.com.au/resources/troubleshooting](http://ecoflo.com.au/resources/troubleshooting)).
- To clean the toilet, use only enzymes. Never use abrasive chemical cleaning agents.
- If the toilet is installed as option B and you plan to leave the house for more than a few days, switch off the fan and put the cover in the toilet opening. If there is a good natural draft no odour will occur.
- If you do experience a bad odour in the room, check the pipe connections are properly sealed and if there is an adequate air supply.

# CONTACT

---

The place of purchase is responsible for handling warranty claims and addressing product concerns during the warranty period.

## AUSTRALIA



Ecoflo Wastewater Management

[ecoflo.com.au](http://ecoflo.com.au)

PH 1300 138 182 or (07) 3889 6144

[info@ecoflo.com.au](mailto:info@ecoflo.com.au)

Available Monday - Friday (excluding public holidays)

## NEW ZEALAND



Waterless Composting Toilets NZ

[wctnz.co.nz](http://wctnz.co.nz)

PH 0800 022 027

[sales@wctnz.co.nz](mailto:sales@wctnz.co.nz)

